

A

· 阻尼减振车刀杆 DAMPING TURNING TOOL HOLDER

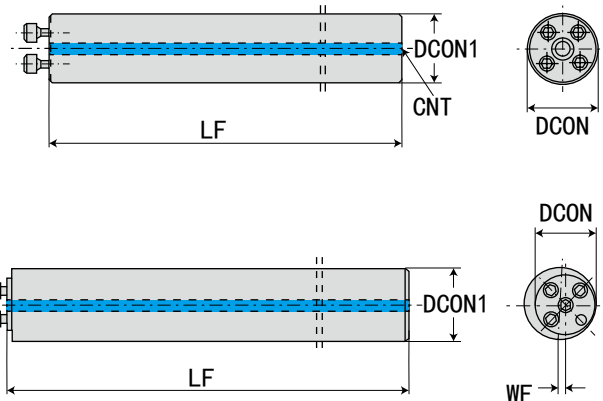

型号 Model	刀杆直径 DCON1	安装面直径 DCON	长度 LF	螺孔 CNT	倍径 L/D	适配刀头 CARTRIDGE	FIG	重量 KG
SD16-C16-156V	16	16	156	G1/8..	7	SD16	1	0.2
-204VE	16	16	204	G1/8..	10	SD16	1	0.5
SD20-C20-200V	20	20	200	G1/4..	7	SD20	1	0.4
-260VE	20	20	260	G1/4..	10	SD20	1	0.8
SD25-C25-255V	25	25	255	G1/4..	7	SD25	1	1
-330VE	25	25	330	G1/4..	10	SD25	1	1.3
-380VE	25	25	380	G1/8..	12	SD25	1	2
-430VE	25	25	430	G1/8..	14	SD25	1	2.6
SD32-C32-320V	32	32	320	G3/8..	7	SD32	1	2.1
-416V	32	32	416	G3/8..	10	SD32	1	2.8
-480VE	32	32	480	G1/4..	12	SD32	1	4.2
-544VE	32	32	544	G1/4..	14	SD32	1	4.8
-408V	40	40	408	G1/2..	7	SD40	1	4.6
-528V	40	40	528	G1/2..	10	SD40	1	5.3
-608VE	40	40	608	G3/8..	12	SD40	1	8.3
-688VE	40	40	688	G3/8..	14	SD40	1	9.4
SD40-C40-408V	40	40	408	G1/2..	7	SD40	2	4.6
-528V	40	40	528	G1/2..	10	SD40	2	5.3
-608VE	40	40	608	G3/8..	12	SD40	2	8.3
-688VE	40	40	688	G3/8..	14	SD40	2	9.4

规格说明:



· 阻尼减振车刀杆 DAMPING TURNING TOOL HOLDER

A
阻尼减振刀具
DAMPING TOOLS

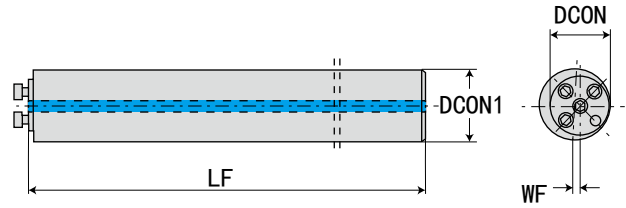

型号 Model	刀杆直径 DCON1	安装面直径 DCON	长度 LF	螺孔 CNT	倍径 L/D	适配刀头 CARTRIDGE	重量 KG
SD40-C50-518V	50	40	518	G1/2..	7	SD40	7.2
-668V	50	40	668	G1/2..	10	SD40	9.3
-768VE	50	40	768	G1/2..	12	SD40	14.4
-868VE	50	40	868	G1/2..	14	SD40	16.6

规格说明:



· 阻尼减振车刀杆 DAMPING TURNING TOOL HOLDER

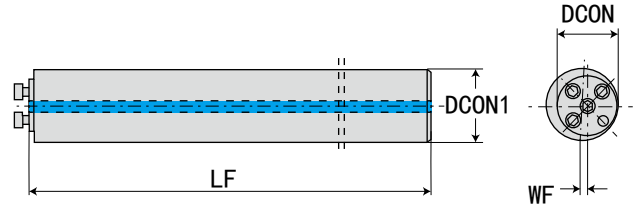

型号 Model	刀杆直径 DCON1	安装面直径 DCON	长度 LF	螺孔 CNT	倍径 L/D	适配刀头 CARTRIDGE	重量 KG
SD40-C60-628V	60	40	628	G3/4..	7	SD40	12.5
-808V	60	40	808	G3/4..	10	SD40	16.3
-920VE	60	40	920	G3/4..	12	SD40	27.1
-1040VE	60	40	1040	G3/4..	14	SD40	30.9

规格说明:

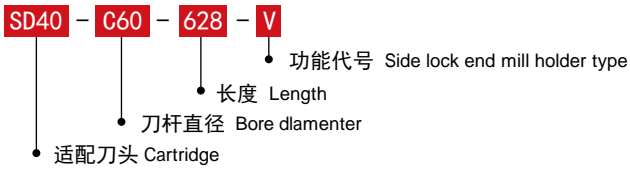

· 阻尼减振车刀杆 DAMPING TURNING TOOL HOLDER

A
阻尼减振刀具
DAMPING TOOLS

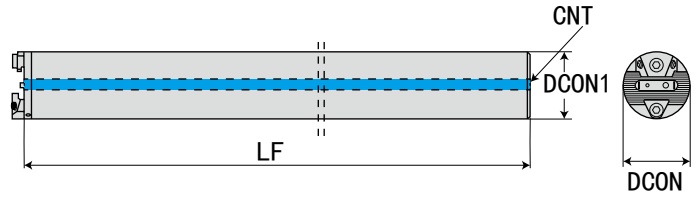

型号 Model	刀杆直径 DCON1	安装面直径 DCON	长度 LF	螺孔 CNT	倍径 L/D	适配刀头 CARTRIDGE	重量 KG
SD80-C80-880V	80	80	880	G3/4..	7	SD80	31.8
-1200V	80	80	1200	G3/4..	10	SD80	52.3
-1240VE	80	80	1240	G3/4..	12	SD80	50
-1400VE	80	80	1400	G3/4..	14	SD80	63

规格说明:

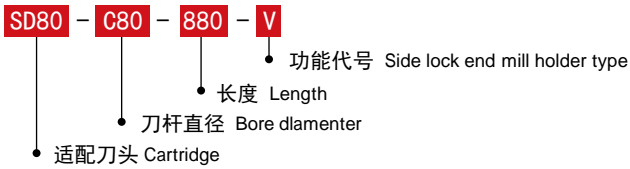

· 阻尼减振车刀杆 DAMPING TURNING TOOL HOLDER

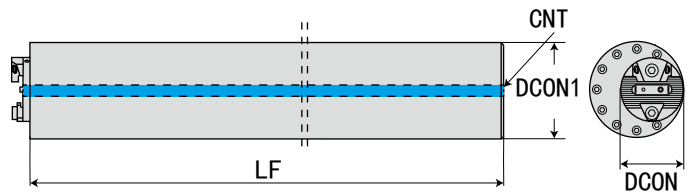

型号 Model	刀杆直径 DCON1	安装面直径 DCON	长度 LF	螺孔 CNT	倍径 L/D	适配刀头 CARTRIDGE	重量 KG
SD80-C100-1100V	100	80	1100	G3/4..	7	SD80	63.4
-1500V	100	80	1500	G3/4..	10	SD80	86.8
-C120-1900V-R/L	120	80	1900	G3/4..	10	SD80	134
-C130-2000V-R/L	130	80	2000	G3/4..	10	SD80	192.3
-C140-2200V-R/L	140	80	2200	G3/4..	10	SD80	241.5
-C150-2400V-R/L	150	80	2400	G3/4..	10	SD80	252.6
-C160-2600V-R/L	160	80	2600	G3/4..	10	SD80	339.3
-C180-2800V-R/L	180	80	2800	G3/4..	10	SD80	458.2
-C200-3200V-R/L	200	80	3200	G3/4..	10	SD80	657.7
-C220-3450V-R/L	220	80	3450	G1..	10	SD80	1059.3
-C250-4000V-R/L	250	80	4000	G1..	10	SD80	1229

规格说明:

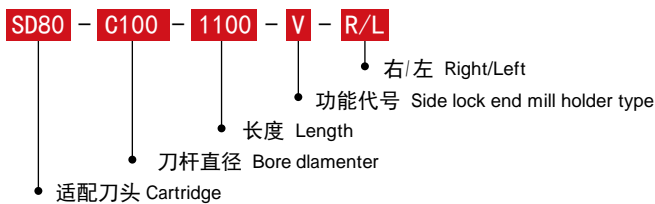

· 阻尼减振车刀杆 DAMPING TURNING TOOL HOLDER

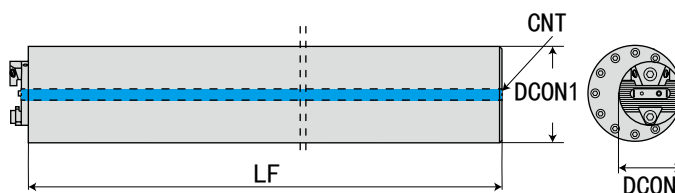

型号 Model	刀杆直径 DCON1	安装面直径 DCON	长度 LF	螺孔 CNT	倍径 L/D	适配刀头 CARTRIDGE	重量 KG
SD80-C100-1560VE	100	80	1560	G3/4..	12	SD80	117.6
-1760VE	100	80	1760	G3/4..	14	SD80	133.3
-C120-1870VE-R/L	120	80	1870	G3/4..	12	SD80	215.7
-2110VE-R/L	120	80	2110	G3/4..	14	SD80	248.6
-C130-2030VE-R/L	130	80	2030	G3/4..	12	SD80	271.4
-2290VE-R/L	130	80	2290	G3/4..	14	SD80	312.3
-C140-2190VE-R/L	140	80	2190	G3/4..	12	SD80	336.7
-2470VE-R/L	140	80	2470	G3/4..	14	SD80	386.8
-C150-2350VE-R/L	150	80	2350	G3/4..	12	SD80	397.2
-2650VE-R/L	150	80	2650	G3/4..	14	SD80	472.4
-C160-2510VE-R/L	160	80	2510	G3/4..	12	SD80	497.5
-2830VE-R/L	160	80	2830	G3/4..	14	SD80	571.2
-C180-2830VE-R/L	180	80	2830	G3/4..	12	SD80	559.7
-3190VE-R/L	180	80	3190	G3/4..	14	SD80	642.6
-C200-3150VE-R/L	200	80	3150	G3/4..	12	SD80	621.9
-3550VE-R/L	200	80	3550	G3/4..	14	SD80	714.3
-C220-3470VE-R/L	220	80	3470	G3/4..	12	SD80	684.1
-3910VE-R/L	220	80	3910	G3/4..	14	SD80	785.7
-C250-3950VE-R/L	250	80	3950	G3/4..	12	SD80	777.4
-4450VE-R/L	250	80	4450	G3/4..	14	SD80	892.8

规格说明:

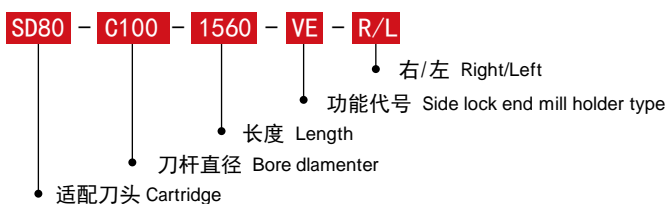

· 正型 95° 正镗刀头 POSITIVE TYPE 95° BORING

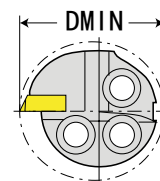
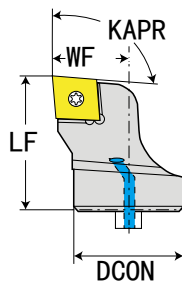

型号 Model	长度 LF	安装面直径 DCON	中心距 WF	范围 DMIN	角度 KAPR	刀片 Insert	重量 KG
SD16-SCLCR-06	20	16	11	20	95°	CC**0602**	0.03
SD20-SCLCR-09	20	20	13	25	95°	CC**09T3**	0.05
SD25-SCLCR-09	20	25	17	32	95°	CC**09T3**	0.07
SD32-SCLCR-09	32	32	22	40	95°	CC**09T3**	0.13
SD40-SCLCR-12	38	40	27	50	95°	CC**1204**	0.24
SD16-SCLCL-06	20	16	11	20	95°	CC**0602**	0.03
SD20-SCLCL-09	20	20	13	25	95°	CC**09T3**	0.05
SD25-SCLCL-09	20	25	17	32	95°	CC**09T3**	0.07
SD32-SCLCL-09	32	32	22	40	95°	CC**09T3**	0.13
SD40-SCLCL-12	38	40	27	50	95°	CC**1204**	0.24

· 备件 SPARE PARTS

型号 Model	螺丝 Screw	旗型扳手 Wrench	刀垫 Shim	刀垫螺套 Sleeve for shim	刀垫扳手 Allen key for shim	定位销 Locating pin
SD16-SCLCR/L-06	SR21-M2.5*0.45P*5	T8	-	-	-	D4-3*7
SD20-SCLCR/L-09	SR21-M4*0.7P*9	T15	-	-	-	D6-5*8
SD25-SCLCR/L-09	SR21-M4*0.7P*9	T15	-	-	-	D6-5*9
SD32-SCLCR/L-09	SR21-M4*0.7P*9	T15	-	-	-	D6-5*11
SD40-SCLCR/L-12	SR21-M5*0.8P*12	T20	ST01-CC12*2.8	SRT-M7-M5*13	KEY01-M3	D6-5*11

规格说明:

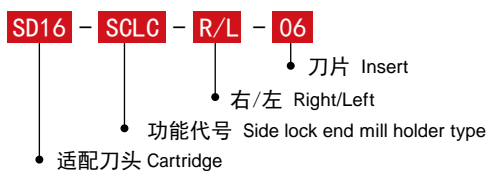

· 正型 93° 正镗刀头 POSITIVE TYPE 93° BORING

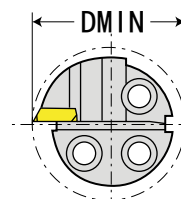
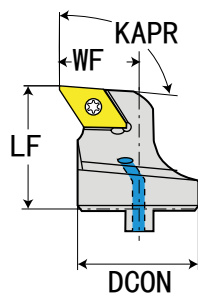

型号 Model	长度 LF	安装面直径 DCON	中心距 WF	范围 DMIN	角度 KAPR	刀片 Insert	重量 KG
SD16-SDUCR-07	20	16	11	20	93°	DC**0702**	0.03
SD20-SDUCR-11	20	20	13	25	93°	DC**11T3**	0.05
SD25-SDUCR-11	20	25	17	32	93°	DC**11T3**	0.07
SD32-SDUCR-11	32	32	22	40	93°	DC**11T3**	0.13
SD40-SDUCR-11	32	40	27	50	93°	DC**11T3**	0.2
SD16-SDUCL-07	20	16	11	20	93°	DC**0702**	0.03
SD20-SDUCL-11	20	20	13	25	93°	DC**11T3**	0.05
SD25-SDUCL-11	20	25	17	32	93°	DC**11T3**	0.07
SD32-SDUCL-11	32	32	22	40	93°	DC**11T3**	0.13
SD40-SDUCL-11	32	40	27	50	93°	DC**11T3**	0.2

· 备件 SPARE PARTS

型号 Model	螺丝 Screw	旗型扳手 Wrench	刀垫 Shim	刀垫螺套 Sleeve for shim	刀垫扳手 Allen key for shim	定位销 Locating pin
SD16-SDUCR/L-07	SR21-M2.5*0.45P*5	T8	-	-	-	D4-3*7
SD20-SDUCR/L-11	SR21-M4*0.7P*11	T15	-	-	-	D6-5*8
SD25-SDUCR/L-11	SR21-M4*0.7P*11	T15	-	-	-	D6-5*9
SD32-SDUCR/L-11	SR21-M4*0.7P*11	T15	ST01-CC11*2.82	SRT-M6-M4*6.9	KEY01-M4	D6-5*11
SD40-SDUCR/L-11	SR21-M4*0.7P*11	T15	ST01-CC11*2.82	SRT-M6-M4*6.9	KEY01-M4	D6-5*11

规格说明:

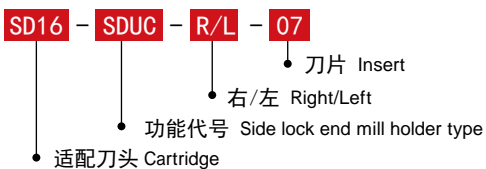

· 正型 93° 正镗仿形刀头 POSITIVE TYPE 93° BORING AND PROFILE - TURNING

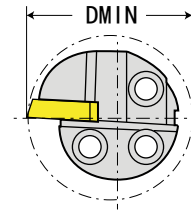
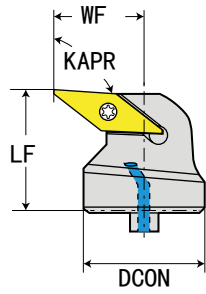

型号 Model	长度 LF	安装面直径 DCON	中心距 WF	范围 DMIN	角度 KAPR	刀片 Insert	重量 KG
SD20-SVUCR-11	20	20	15	27	93 度	VC**1103**	0.05
SD25-SVUCR-11	20	25	18	33	93 度	VC**1103**	0.06
SD20-SVUCL-11	20	20	15	27	93 度	VC**1103**	0.05
SD25-SVUCL-11	20	25	18	33	93 度	VC**1103**	0.06

· 备件 SPARE PARTS

型号 Model	螺丝 Screw	旗型扳手 Wrench	定位销 Locating pin
SD20-SVUCR/L-11	SR21 - M2.5*0.45P*6	T8	D6-5*8
SD25-SVUCR/L-11	SR21 - M2.5*0.45P*6	T8	D6-5*9

规格说明:

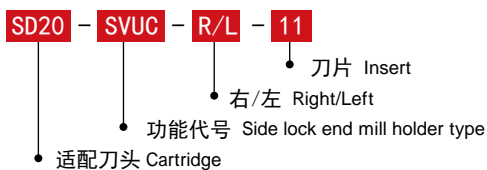

· 正型 95° 正镗仿形刀头 POSITIVE TYPE 95° BORING AND PROFILE - TURNING

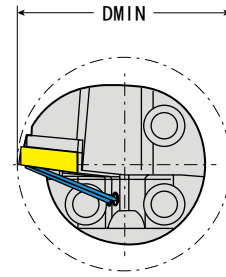
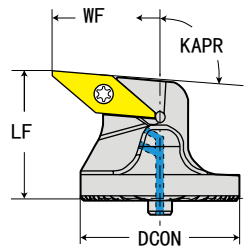

型号 Model	长度 LF	安装面直径 DCON	中心距 WF	范围 DMIN	角度 KAPR	刀片 Insert	重量 KG
SD32-SVLBR-16	32	32	22	40	95 度	VC**1604**	0.13
SD40-SVLBR-16	32	40	27	50	95 度	VC**1604**	0.19
SD32-SVLBL-16	32	32	22	40	95 度	VC**1604**	0.13
SD40-SVLBL-16	32	40	27	50	95 度	VC**1604**	0.19

· 备件 SPARE PARTS

型号 Model	螺丝 Screw	旗型扳手 Wrench	刀垫 Shim	刀垫螺套 Sleeve for shim	刀垫扳手 Allen key for shim	定位销 Locating pin
SD32-SVLBR/L-16	SR21-M4*0.7P*11	T15	ST01-CC16*2.82	SRT-M6-M4*6.9	KEY01-M4	D6-5*11
SD40-SVLBR/L-16	SR21-M4*0.7P*11	T15	ST01-CC16*2.82	SRT-M6-M4*6.9	KEY01-M4	D6-5*11

规格说明:

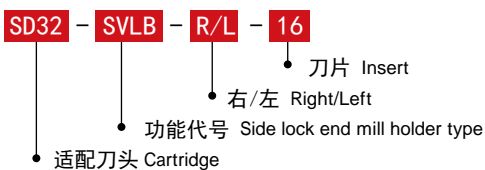

· 正型 62.5° 仿形刀头 POSITIVE TYPE 62.5° PROFILE-TURNING

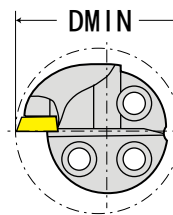
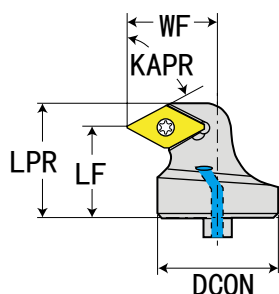

型号 Model	长度 LF	安装面直径 DCON	全长 LPR	中心距 WF	范围 DMIN	角度 KARP	刀片 Insert	重量 KG
SD16-SDXCR-07	15	16	18.8	13	22	62.5°	DC**0702**	0.03
SD20-SDXCR-07	15	20	18.8	15	27	62.5°	DC**0702**	0.04
SD25-SDXCR-07	15	25	18.8	18	33	62.5°	DC**0702**	0.06
SD32-SDXCR-11	20	32	28	22	40	62.5°	DC**11T3**	0.12
SD40-SDXCR-11	20	40	28	27	50	62.5°	DC**11T3**	0.18
SD16-SDXCL-07	15	16	18.8	13	22	62.5°	DC**0702**	0.03
SD20-SDXCL-07	15	20	18.8	15	27	62.5°	DC**0702**	0.04
SD25-SDXCL-07	15	25	18.8	18	33	62.5°	DC**0702**	0.06
SD32-SDXCL-11	20	32	28	22	40	62.5°	DC**11T3**	0.12
SD40-SDXCL-11	20	40	28	27	50	62.5°	DC**11T3**	0.18

· 备件 SPARE PARTS

型号 Model	螺丝 Screw	旗型扳手 Wrench	刀垫 Shim	刀垫螺套 Sleeve for shim	刀垫扳手 Allen key for shim	定位销 Locating pin
SD16-SDXCR/L-07	SR21 - M2.5*0.45P*5	T8	-	-	-	D4-3*7
SD20-SDXCR/L-07	SR21 - M2.5*0.45P*5	T8	-	-	-	D6-5*8
SD25-SDXCR/L-07	SR21 - M2.5*0.45P*5	T8	-	-	-	D6-5*9
SD32-SDXCR/L-11	SR21 - M4*0.7P*11	T15	ST01 - CC11*2.82	SRT - M6 - M4*6.9	KEY01 - M4	D6-5*11
SD40-SDXCR/L-11	SR21 - M4*0.7P*11	T15	ST01 - CC11*2.82	SRT - M6 - M4*6.9	KEY01 - M4	D6-5*11

规格说明:

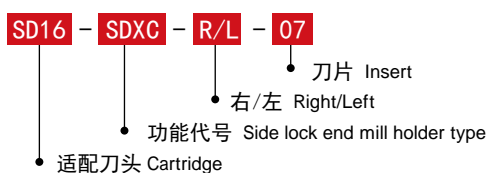

· 正型 93° 反镗刀头

POSITIVE TYPE 93° BACK BORING

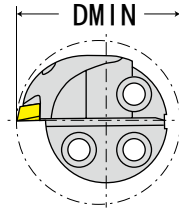
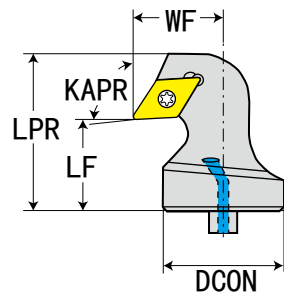

型号 Model	长度 LF	安装面直径 DCON	全长 LPR	中心距 WF	范围 DMIN	角度 KARP	刀片 Insert	重量 KG
SD16-SDUCR-07	15	16	26.6	13	22	93°	DC**0702**	0.03
SD20-SDUCR-07	15	20	26.6	15	27	93°	DC**0702**	0.05
SD25-SDUCR-07	15	25	26.6	18	33	93°	DC**0702**	0.06
SD32-SDUCR-11	20	32	37	22	40	93°	DC**11T3**	0.14
SD40-SDUCR-11	20	40	37	27	50	93°	DC**11T3**	0.22
SD16-SDUCL-07	15	16	26.6	13	22	93°	DC**0702**	0.03
SD20-SDUCL-07	15	20	26.6	15	27	93°	DC**0702**	0.05
SD25-SDUCL-07	15	25	26.6	18	33	93°	DC**0702**	0.06
SD32-SDUCL-11	20	32	37	22	40	93°	DC**11T3**	0.14
SD40-SDUCL-11	20	40	37	27	50	93°	DC**11T3**	0.22

· 备件 SPARE PARTS

型号 Model	螺丝 Screw	旗型扳手 Wrench	刀垫 Shim	刀垫螺套 Sleeve for shim	刀垫扳手 Allen key for shim	定位销 Locating pin
SD16-SDUCR/L-07	SR21 - M2.5*0.45P*5	T8	-	-	-	D4-3*7
SD20-SDUCR/L-07	SR21 - M2.5*0.45P*5	T8	-	-	-	D6-5*8
SD25-SDUCR/L-07	SR21 - M2.5*0.45P*5	T8	-	-	-	D6-5*9
SD32-SDUCR/L-11	SR21 - M4*0.7P*11	T15	ST01 - CC11*2.82	SRT - M6 - M4*6.9	KEY01 - M4	D6-5*11
SD40-SDUCR/L-11	SR21 - M4*0.7P*11	T15	ST01 - CC11*2.82	SRT - M6 - M4*6.9	KEY01 - M4	D6-5*11

规格说明:

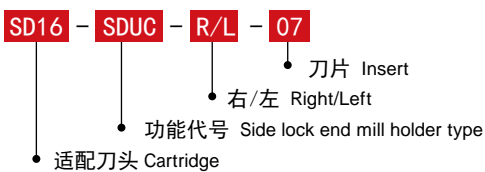

A
阻尼减振刀具
DAMPING TOOLS

· 正型 91° 正镗刀头

POSITIVE TYPE 91° PROFILE - TURNING

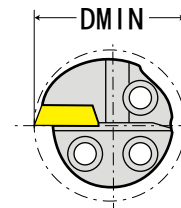
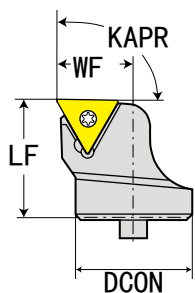

型号 Model	长度 LF	安装面直径 DCON	中心距 WF	范围 DMIN	角度 KARP	刀片 Insert	重量 KG
SD16-STFCR-09	20	16	11	20	91°	TC**0902**	0.03
SD16-STFCR-11	20	16	11	20	91°	TC**1102**	0.03
SD20-STFCR-11	20	20	13	25	91°	TC**1102**	0.04
SD25-STFCR-11	20	25	17	32	91°	TC**1102**	0.06
SD32-STFCR-16	32	32	22	40	91°	TC**16T3**	0.14
SD40-STFCR-16	32	40	27	50	91°	TC**16T3**	0.21
SD16-STFCL-09	20	16	11	20	91°	TC**0902**	0.03
SD16-STFCL-11	20	16	11	20	91°	TC**1102**	0.03
SD20-STFCL-11	20	20	13	25	91°	TC**1102**	0.04
SD25-STFCL-11	20	25	17	32	91°	TC**1102**	0.06
SD32-STFCL-16	32	32	22	40	91°	TC**16T3**	0.14
SD40-STFCL-16	32	40	27	50	91°	TC**16T3**	0.21

· 备件 SPARE PARTS

型号 Model	螺丝 Screw	旗型扳手 Wrench	定位销 Locating pin
SD16-STFCR/L-09	SR21 - M2.2*0.45P*5.5	T7	D4 - 3*7
SD16-STFCR/L-11	SR21 - M2.5*0.45P*6	T8	D4 - 3*7
SD20-STFCR/L-11	SR21 - M2.5*0.45P*6	T8	D6 - 5*8
SD25-STFCR/L-11	SR21 - M2.5*0.45P*6	T8	D6 - 5*9
SD32-STFCR/L-16	SR21 - M4*0.7P*9.5	T15	D6 - 5*11
SD40-STFCR/L-16	SR21 - M4*0.7P*9.5	T15	D6 - 5*11

规格说明:

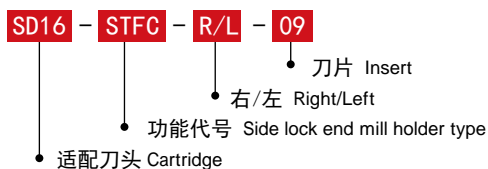

· 负型 95° 正镗刀头

NEGATIVE TYPE 91° PROFILE - TURNING

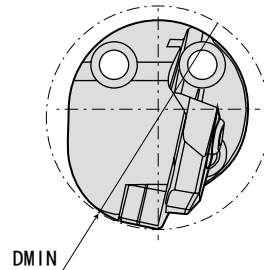
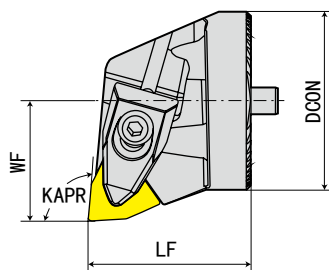

型号 Model	长度 LF	安装面直径 DCON	中心距 WF	范围 DMIN	角度 KAPR	刀片 Insert	重量 KG
SD32-DWLNR-06T	32	32	22	40	95度	WN**0604**	0.11
SD32-DWLNR-08T	36	32	24	46	95度	WN**0804**	0.12
SD40-DWLNR-08T	36	40	27	50	95度	WN**0804**	0.23
SD32-DWLN-06T	32	32	22	40	95度	WN**0604**	0.11
-08T	36	32	24	46	95度	WN**0804**	0.12
SD40-DWLN-08T	36	40	27	50	95度	WN**0804**	0.23

· 备件 SPARE PARTS

型号 Model	压板 Clamping pad	压板弹簧 Spring for clampin pad	压板螺钉 Screw for clampin pad	刀垫 Shim	压板扳手 Allen key for clampin pad	刀垫锁紧螺钉 Clamping screw for shim	刀垫扳手 Allen key for shim	定位销 Locating pin
SD32-DWLNR/L-06T	PB10DDN11	YH7*0.6*13	SR59M4*16	ST01WN06*3.18	KEY01 - M2.5	SR20 - M4*0.7P*9.5	KEY02 - T15	D6 - 5*11
SD32-DWLNR/L-08T	PB10DCN12	YH8*0.6*13	SR59M5*20	ST01WN08*3.18	KEY01 - M3	SR20 - M5*0.8P*10	KEY02 - T20	D6 - 5*11
SD40-DWLNR/L-08T	PB10DCN12	YH8*0.6*13	SR59M5*20	ST01WN08*6.35	KEY01 - M3	SR20 - M4*0.7P*9.5	KEY02 - T15	D6 - 5*11

规格说明:

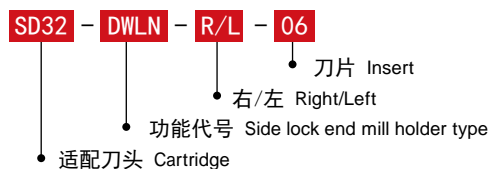

· 正型 93° 反镗仿形刀头 POSITIVE TYPE 93° BACK BORING PROFILE - TURNING

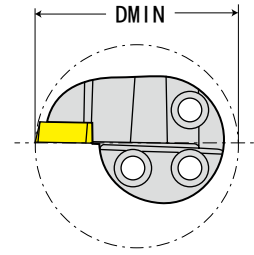
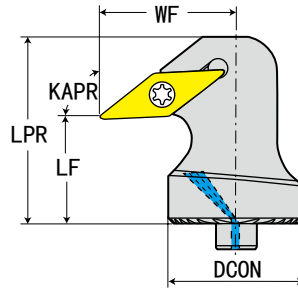

型号 Model	长度 LF	安装面直径 DCON	全长 LPR	中心距 WF	范围 DMIN	角度 KARP	刀片 Insert	重量 KG
SD20-SVUCR-11	15	20	27	20	32	93°	VC**1103**	0.05
SD25-SVUCR-11	15	25	27	22	37	93°	VC**1103**	0.08
SD20-SVUCL-11	15	20	27	20	32	93°	VC**1103**	0.05
SD25-SVUCL-11	15	25	27	22	37	93°	VC**1103**	0.08

· 备件 SPARE PARTS

型号 Model	螺丝 Screw	旗型扳手 Wrench	定位销 Locating pin
SD20-SVUCR/L-11	SR20-M2.5*0.45P*6	T8	D6-5*8
SD25-SVUCR/L-11	SR20-M2.5*0.45P*6	T8	D6-5*9

规格说明:

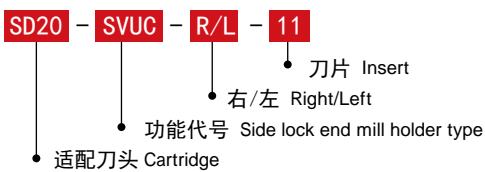

· 负型 95° 正镗刀头 NEGATIVE TYPE 95° BORING

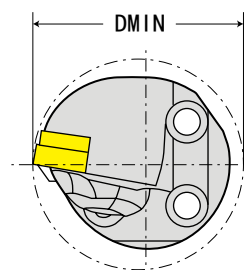
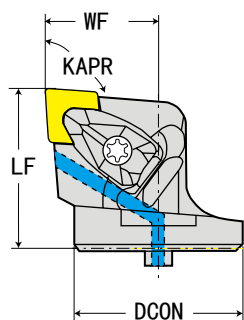

型号 Model	长度 LF	安装面直径 DCON	中心距 WF	范围 DMIN	角度 KARP	刀片 Insert	重量 KG
SD32-DCLNR-12	38	32	22	40	95°	CN**1204**	0.17
SD40-DCLNR-12	38	40	27	50	95°	CN**1204**	0.22
SD40-DCLNR-16	40	40	32	57	95°	CN**1606**	0.32
SD40-DCLNR-19	42	40	34	57	95°	CN**1906**	0.33
SD32-DCLNL-12	38	32	22	40	95°	CN**1204**	0.17
SD40-DCLNL-12	38	40	27	50	95°	CN**1204**	0.22
SD40-DCLNL-16	40	40	32	57	95度	CN**1606**	0.32
SD40-DCLNL-19	42	40	34	57	95度	CN**1906**	0.33

· 备件 SPARE PARTS

型号 Model	压板 Clamping pad	压板弹簧 Spring for clampin pad	压板螺钉 Screw for clampin pad	刀垫 Shim	压板扳手 Allen key for clampin pad	刀垫锁紧螺钉 Clamping screw for shim	刀垫扳手 Allen key for shim	定位销 Locating pin
SD32-DCLNR/L-12	PB10DCN12	YH8*0.6*13	SR59M5*20	ST01CN12*3.2	KEY01-M3	SR20-M5*0.8P*10	KEY02-T20	D6-5*11
SD40-DCLNR/L-12	PB10DCN12	YH8*0.6*13	SR59M5*20	ST01CN12*3.2	KEY01-M3	SR20-M5*0.8P*10	KEY02-T20	D6-5*11
SD40-DCLNR/L-16	PB10DCN16	YH9*0.8*14	SR59M6*26.5	ST01CN16*3.2	KEY01-M4	-	KEY02-T20	-
SD40-DCLNR/L-19	PB10DCN19	-	-	-	-	-	-	-

规格说明:

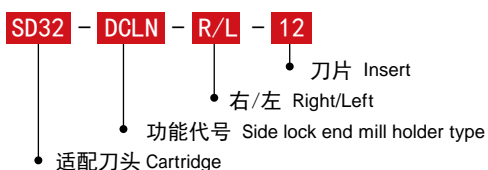

· 负型 93° 正镗仿形刀头 NEGATIVE TYPE 93° BORING AND PROFILE-TURNING

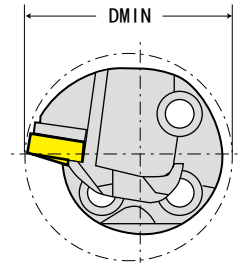
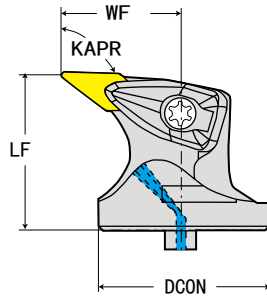

型号 Model	长度 LF	安装面直径 DCON	全长 LPR	中心距 WF	范围 DMIN	角度 KARP	刀片 Insert	重量 KG
SD40-DVUNR-16	20	40	38.5	34	56	93度	VN**1604**	0.26
SD40-DVUNL-16	20	40	38.5	34	56	93度	VN**1604**	0.26

· 备件 SPARE PARTS

型号 Model	压板 Clamping pad	压板弹簧 Spring for clampin pad	压板螺钉 Screw for clampin pad	刀垫 Shim	压板扳手 Allen key for clampin pad	刀垫锁紧螺钉 Clamping screw for shim	刀垫扳手 Allen key for shim	定位销 Locating pin
SD40-DVUNR/L-16	PB10DVN16	YH9*0.8*14	SR59M6*26.5	ST01VN16*3.2	KEY01-M4	SR20-M3.5*0.6P*8.5	KEY02-T10	D6-5*11

规格说明:

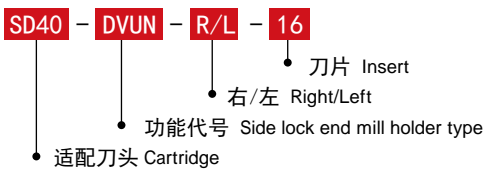

· 负型 93° 正镗仿形刀头 NEGATIVE TYPE 93° BORING AND PROFILE - TURNING

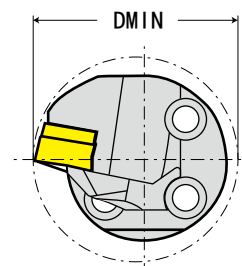
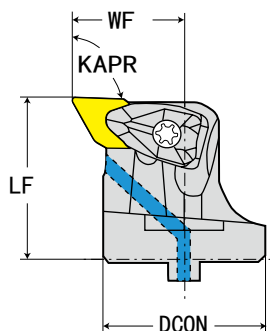

型号 Model	长度 LF	安装面直径 DCON	中心距 WF	范围 DMIN	角度 KAPR	刀片 Insert	重量 KG
SD32-DDUNR-11	32	32	22	40	93°	DN**1104**	0.13
SD40-DDUNR-15	32	40	27	50	93°	DN**1506**	0.21
SD32-DDUNL-11	32	32	22	40	93°	DN**1104**	0.13
SD40-DDUNL-15	32	40	27	50	93°	DN**1506**	0.21

· 备件 SPARE PARTS

型号 Model	压板 Clamping pad	压板弹簧 Spring for clampin pad	压板螺钉 Screw for clampin pad	刀垫 Shim	压板扳手 Allen key for clampin pad	刀垫锁紧螺钉 Clamping screw for shim	刀垫扳手 Allen key for shim	定位销 Locating pin
SD32-DDUNR/L-11	PB10DDN11	YH7*0.6*13	SR59M4*16	ST01DN11*3.18	KEY01 - M2.5	SR21 - M4*0.7P*9.5	KEY02 - T15	D6 - 5*11
SD40-DDUNR/L-15	PB10DCN12	YH8*0.6*13	SR59M5*20	ST01DN15*4.76	KEY01 - M3	SR20 - M4*0.7P*11.5	KEY02 - T15	D6 - 5*11

规格说明:

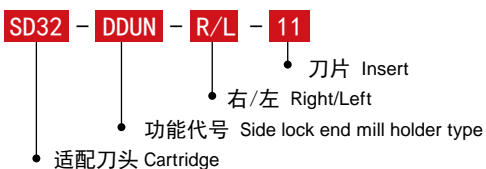

· 正型 95° 正镗刀头

POSITIVE TYPE 95° BORING

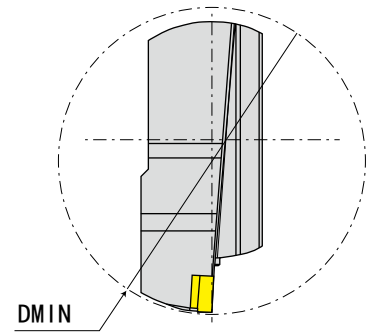
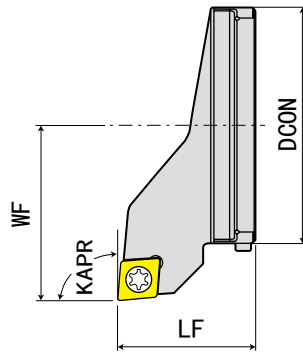

型号 Model	长度 LF	安装面直径 DCON	中心距 WF	范围 DMIN	厚度 H	角度 KAPR	刀片 Insert	重量 KG
SD80-SCLCR-12	45	80	57	100	37.5	95°	CC**1204**	0.55
SD80-SCLCL-12	45	80	57	100	37.5	95°	CC**1204**	0.55

· 备件 SPARE PARTS

型号 Model	压板 Clamping pad	压板弹簧 Spring for clampin pad	压板螺钉 Screw for clampin pad	刀垫 Shim	压板扳手 Allen key for clampin pad	刀垫锁紧螺钉 Clamping screw for shim	刀垫扳手 Allen key for shim
SD80-SCLCR/L-12	PB10DCN12	YH8*0.6*13	SR59M5*20	ST01CN12*3.2	KEY01 - M3	SR20 - M5*0.8P*10	KEY02 - T20

规格说明:

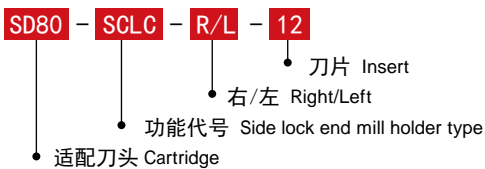

· 负型 95° 正镗刀头 NEGATIVE TYPE 95° BORING

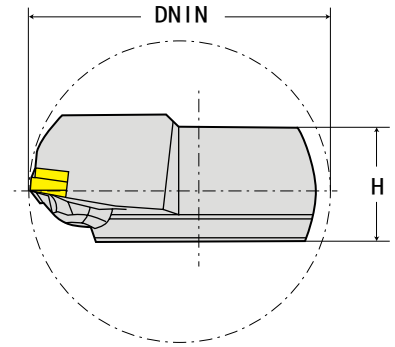
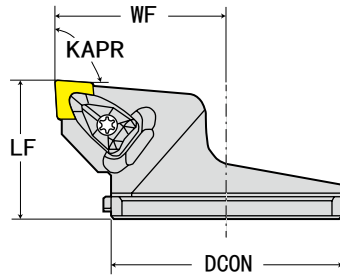

型号 Model	长度 LF	安装面直径 DCON	中心距 WF	范围 DMIN	厚度 H	角度 KARP	刀片 Insert	重量 KG
SD80-DCLNR-12	45	80	57	100	37.5	95°	CN**1204**	0.56
SD80-DCLNR-16	45	80	57	100	37.5	95°	CN**1606**	0.6
SD80-DCLNL-12	45	80	57	100	37.5	95°	CN**1204**	0.56
SD80-DCLNL-16	45	80	57	100	37.5	95°	CN**1606**	0.6

· 备件 SPARE PARTS

型号 Model	压板 Clamping pad	压板弹簧 Spring for clampin pad	压板螺钉 Screw for clampin pad	刀垫 Shim	压板扳手 Allen key for clampin pad	刀垫锁紧螺钉 Clamping screw for shim	刀垫扳手 Allen key for shim
SD80-DCLNR/L-12	PB10DCN12	YH8*0.6*13	SR59M5*20	ST01CN12*3.2	KEY01-M3	SR20-M5*0.8P*10	KEY02-T20
SD80-DCLNR/L-16	PB10DCN16	YH9*0.8*14	SR59M6*26.5	ST01CN16*3.2	KEY01-M4	-	KEY02-T20

规格说明:

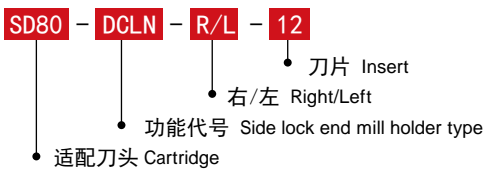

A

· 负型 93° 正镗仿形刀头 NEGATIVE TYPE 93° BORING AND PROFILE-TURNING

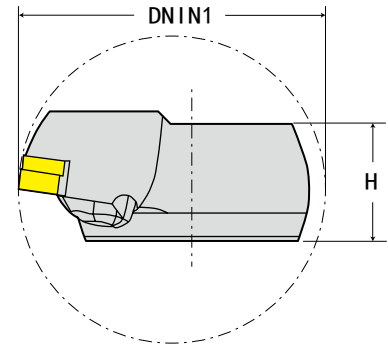
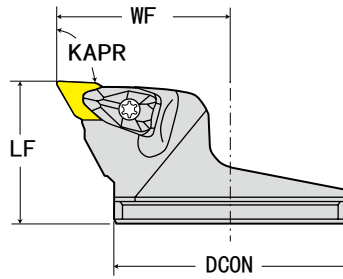

型号 Model	长度 LF	安装面直径 DCON	中心距 WF	范围 DMIN	厚度 H	角度 KARP	刀片 Insert	重量 KG
SD80-DDUNR-15	45	80	57	100	37.5	93°	DN**1506**	0.55
SD80-DDUNL-15	45	80	57	100	37.5	93°	DN**1506**	0.55

· 备件 SPARE PARTS

型号 Model	压板 Clamping pad	压板弹簧 Spring for clampin pad	压板螺钉 Screw for clampin pad	刀垫 Shim	压板扳手 Allen key for clampin pad	刀垫锁紧螺钉 Clamping screw for shim	刀垫扳手 Allen key for shim
SD80-DDUNR/L-15X	PB10DCN12	YH8*0.6*13	SR59M5*20	ST01DN15*4.76	KEY01-M3	SR20-M4*0.7P*11.5	KEY02-T15

规格说明:

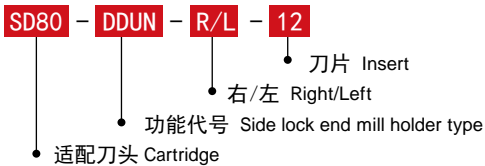

· 负型 93° 反镗仿形刀头 NEGATIVE TYPE 93° BACK BORING AND PROFILE - TURNING

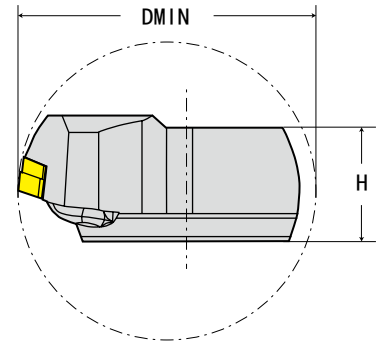
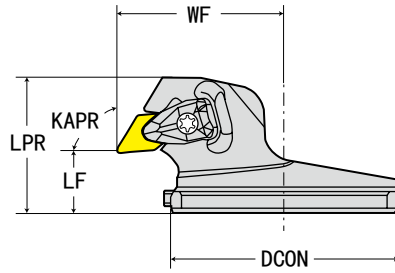

型号 Model	长度 LF	安装面直径 DCON	全长 LPR	中心距 WF	范围 DMIN	厚度 H	角度 KAPR	刀片 Insert	重量 KG
SD80-DDUNR-15X	20	80	45	57	100	37.5	93°	DN**1506**	0.55
SD80-DDUNL-15X	20	80	45	57	100	37.5	93°	DN**1506**	0.55

· 备件 SPARE PARTS

型号 Model	压板 Clamping pad	压板弹簧 Spring for clampin pad	压板螺钉 Screw for clampin pad	刀垫 Shim	压板扳手 Allen key for clampin pad	刀垫锁紧螺钉 Clamping screw for shim	刀垫扳手 Allen key for shim
SD80-DDUNR/L-15X	PB10DCN12	YH8*0.6*13	SR59M5*20	ST01DN15*4.76	KEY01-M3	SR20-M4*0.7P*11.5	KEY02-T15

规格说明:

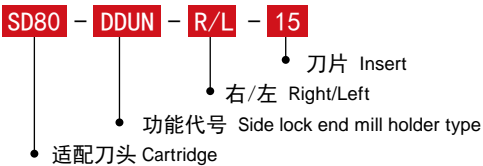

A

· 负型 62.5° 仿形刀头

NEGATIVE TYPE 62.5° BORING AND PROFILE - TURNING

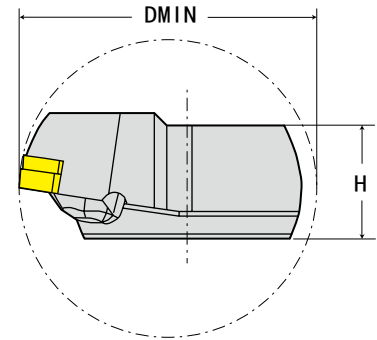
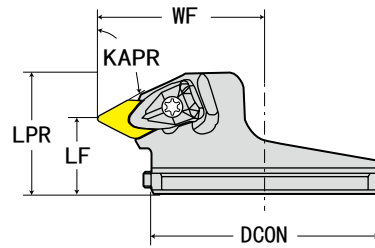

型号 Model	长度 LF	安装面直径 DCON	全长 LPR	中心距 WF	范围 DMIN	厚度 H	角度 KARP	刀片 Insert	重量 KG
SD80-DDXNR-15	25	80	40.3	57	100	37.5	62.5	DN**1506**	0.5
SD80-DDXNL-15	25	80	40.3	57	100	37.5	62.5	DN**1506**	0.5

· 备件 SPARE PARTS

型号 Model	压板 Clamping pad	压板弹簧 Spring for clampin pad	压板螺钉 Screw for clampin pad	刀垫 Shim	压板扳手 Allen key for clampin pad	刀垫锁紧螺钉 Clamping screw for shim	刀垫扳手 Allen key for shim
SD80-DDXNR/L-15	PB10DCN12	YH8*0.6*13	SR59M5*20	ST01DN15*4.76	KEY01 - M3	SR20 - M4*0.7P*11.5	KEY02 - T15

规格说明:

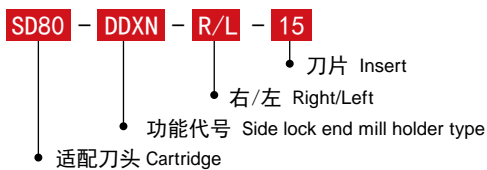

· 负型 93° 反镗仿形刀头 NEGATIVE TYPE 93° BACK BORING AND PROFILE - TURNING

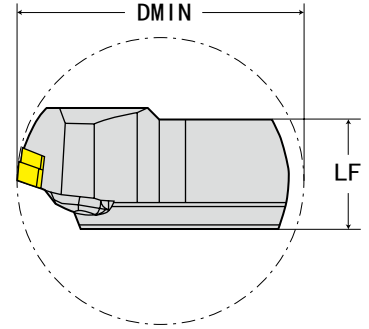
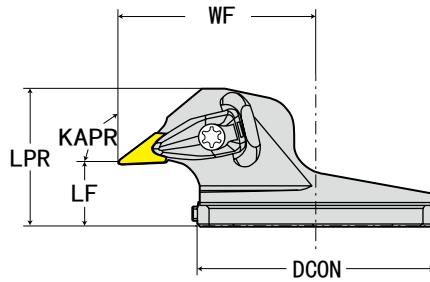

型号 Model	长度 LF	安装面直径 DCON	全长 LPR	中心距 WF	范围 DMIN	厚度 H	角度 KARP	刀片 Insert	重量 KG
SD80-DVUNR-16X	20	80	45	64	100	37.5	93°	VN**1604**	0.55
SD80-DVUNL-16X	20	80	45	64	100	37.5	93°	VN**1604**	0.55

· 备件 SPARE PARTS

型号 Model	压板 Clamping pad	压板弹簧 Spring for clampin pad	压板螺钉 Screw for clampin pad	刀垫 Shim	压板扳手 Allen key for clampin pad	刀垫锁紧螺钉 Clamping screw for shim	刀垫扳手 Allen key for shim
SD80-DVUNR/L-16X	PB10DVN16	YH9*0.8*14	SR59M6*26.5	ST01VN16*3.2	KEY01 - M4	SR20 - M3.5*0.6P*8.5	KEY02 - T10

规格说明:

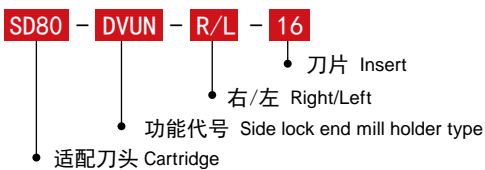

A

· 正型 93° 正镗仿形刀头 POSITIVE TYPE 93° BORING AND PROFILE - TURNING

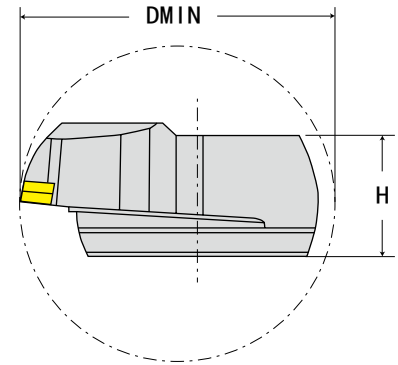
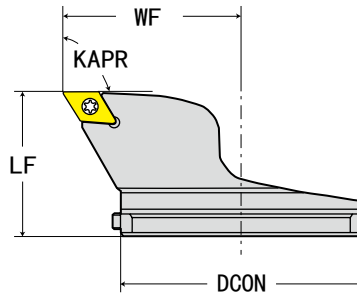

型号 Model	长度 LF	安装面直径 DCON	中心距 WF	范围 DMIN	厚度 H	角度 KARP	刀片 Insert	重量 KG
SD80-SDUCR-11	45.7	80	57	100	37.5	93°	DC**11T3**	0.55
SD80-SDUCL-11	45.7	80	57	100	37.5	93°	DC**11T3**	0.55

· 备件

SPARE PARTS

型号 Model	螺丝 Screw	旗型扳手 Wrench	刀垫 Shim	刀垫螺套 Sleeve for shim	刀垫扳手 Allen key for shim
SD80-SDUCR/L-11	SR21 - M4*0.7P*11	T15	ST01 - CC11*2.82	SRT - M6 - M4*6.9	KEY01 - M4

规格说明:

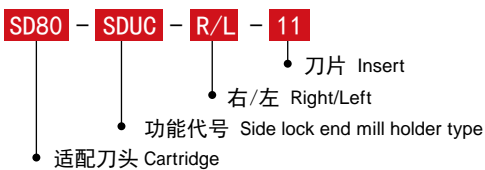

· 正型 95° 正镗仿形刀头 POSITIVE TYPE 95° BORING AND PROFILE-TURNING

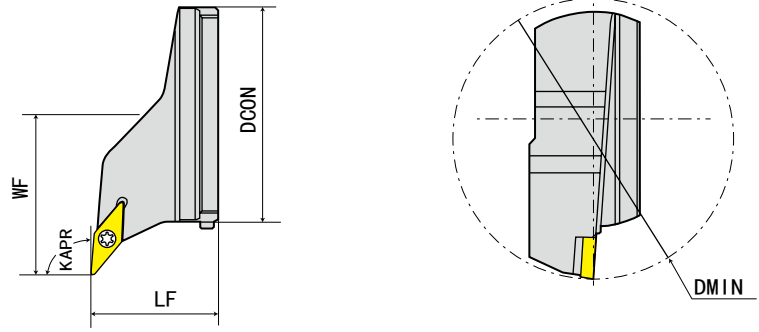

型号 Model	长度 LF	安装面直径 DCON	中心距 WF	范围 DMIN	厚度 H	角度 KARP	刀片 Insert	重量 KG
SD80-SVLCR-16T	45	80	57	100	37.5	95°	VC**1604**	0.44
SD80-SVLCL-16T	45	80	57	100	37.5	95°	VC**1604**	0.44

· 备件 SPARE PARTS

型号 Model	螺丝 Screw	旗型扳手 Wrench	刀垫 Shim	刀垫螺套 Sleeve for shim	刀垫扳手 Allen key for shim
SD80-SVLCR/L-16T	SR21 - M4*0.7P*11	T15	ST01 - CC16*2.82	SRT - M6 - M4*6.9	KEY01 - M4

规格说明:

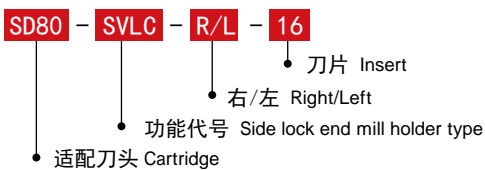

· 槽刀刀头 GROOVING HEAD

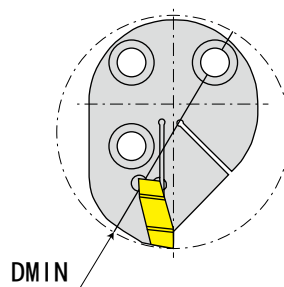
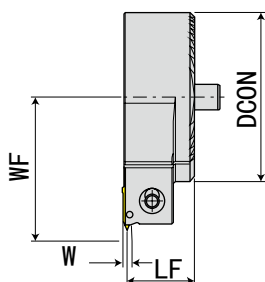

型号 Model	长度 LF	安装面直径 DCON	中心距 WF	范围 DMIN	槽宽 W	刀片 Insert	重量 KG
SD25-GIR/L-2	14	25	17.5	31	2	HG2002	0.45
-3	14	25	17.5	31	3	HG3003	0.45
SD32-GIR/L-2	18	32	20	37	2	HG2002	0.45
-3	18	32	20	37	3	HG3003	0.45
SD40-GIR/L-2	18	40	24	45	2	HG2002	0.45
-3	18	40	25	46	3	HG3003	0.45
-4	18	40	28	49	4	HG4004	0.45

· 备件 SPARE PARTS

型号 Model	螺丝 Screw	旗型扳手 Wrench	定位销 Locating pin
SD25-GIR/L-2	SR55-M4*0.7P*12	KEY01-M3	D6-5*9
-3	SR55-M4*0.7P*12	KEY01-M3	D6-5*9
SD32-GIR/L-2	SR55-M4*0.7P*12	KEY01-M3	D6-5*11
-3	SR55-M4*0.7P*12	KEY01-M3	D6-5*11
SD40-GIR/L-2	SR55-M4*0.7P*12	KEY01-M3	D6-5*11
-3	SR55-M4*0.7P*12	KEY01-M3	D6-5*11
-4	SR55-M4*0.7P*12	KEY01-M3	D6-5*11

规格说明:

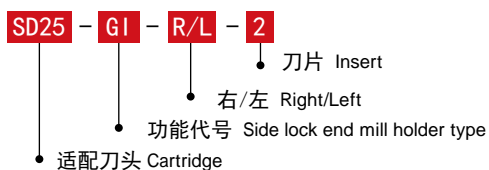

· 螺纹刀头 THREADING TOOL CARTRIDGE

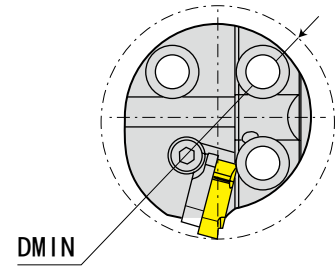
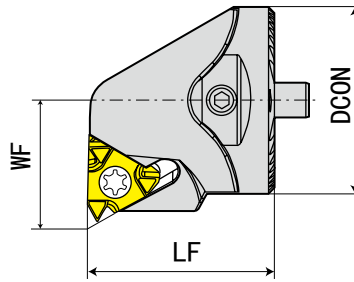

型号 Model	长度 LF	安装面直径 DCON	中心距 WF	范围 DMIN	刀片 Insert	重量 KG
SD20-SIR/L-16	25	20	14	25	16IR/L	0.04
SD25-SIR/L-16T	25	25	17	32	16IR/L	0.05
SD32-SIR/L-16T	32	32	22	40	16IR/L	0.11
SD32-SIR/L-22T	32	32	22	40	22IR/L	0.11
SD40-SIR/L-16T	32	40	27	50	16IR/L	0.17
SD40-SIR/L-22T	32	40	27	50	22IR/L	0.17

· 备件 SPARE PARTS

型号 Model	螺丝 Screw	旗型扳手 Wrench	刀垫 Shim	刀垫螺套 Sleeve for shim	定位销 Locating pin
SD20-SIR/L-16	SR20-M3.5*0.6P*11.5	KEY02-T10	*	*	D6-5*9
SD25-SIR/L-16T	SR20-M3.5*0.6P*11.5	KEY02-T10	A16	SR55-M3*6	D6-5*9
SD32-SIR/L-16T	SR20-M3.5*0.6P*11.5	KEY02-T10	A16	SR55-M3*6	D6-5*11
SD32-SIR/L-22T	SR20-M4*0.7P*15	KEY02-T15	A22	SR55-M3*6	D6-5*11
SD40-SIR/L-16T	SR20-M3.5*0.6P*11.5	KEY02-T10	A16	SR55-M3*6	D6-5*11
SD40-SIR/L-22T	SR20-M4*0.7P*15	KEY02-T15	A22	SR55-M3*6	D6-5*11

规格说明:

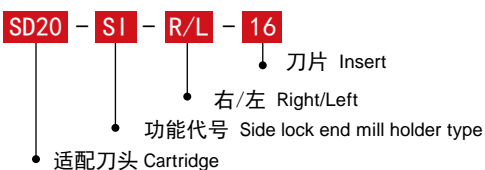

· 中心校正块 CENTRE CALIBRATION BLOCK

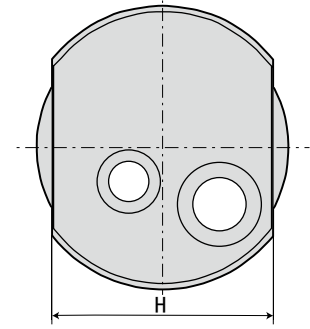
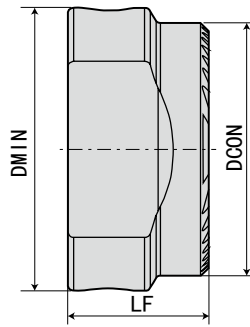

型号 Model	长度 LF	安装面直径 DCON	范围 DMIN	H	重量 KG
SDXZ16-25	14	25	28	22	0.05
SDXZ32-60	25	60	62	52	0.45

· 阻尼减振刀杆专用变径套 DAMPING TOOL SLEEVE

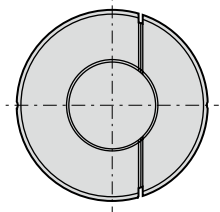
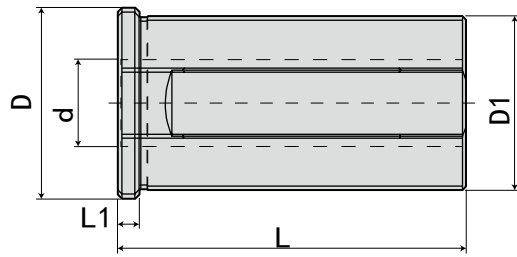

型号 Model	D	D1	d	L	L1	重量 KG
SD32-16-65	36	32	16	65	5	
SD32-20-65	36	32	20	65	5	
SD32-20-85	38	32	20	85	5	
SD40-16-75	44	40	16	75	5	
SD40-20-75	44	40	20	75	5	
SD40-20-105	46	40	20	105	5	
SD40-25-75	44	40	25	75	5	
SD40-25-105	46	40	25	105	5	
SD40-32-128	50	40	32	128	5	
SD50-20-125	56	50	20	125	5	
SD50-25-125	56	50	25	125	5	
SD50-32-128	60	50	32	128	5	
SD50-40-160	60	50	40	160	5	
SD60-32-128	70	60	32	128	5	
SD60-40-160	70	60	40	160	5	
SD60-50-200	70	60	50	200	5	

A

· 转换刀座 CONVERSION TOOL HOLDER

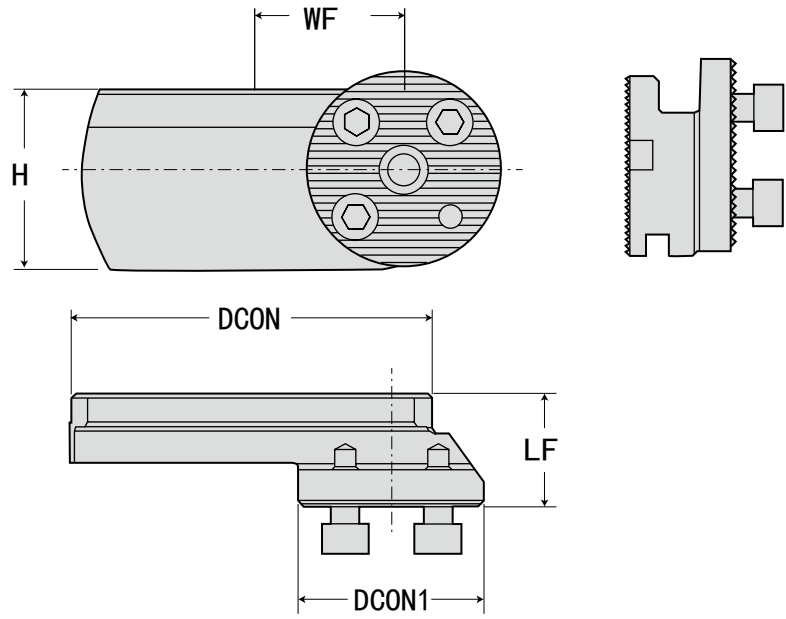

型号 Model	长度 LF	安装面直径 DCON	安装面直径 DCON1	H	中心距 WF	重量 KG
SD80-23-40R/L	23	80	40	37.5	70	0.3



· 转换刀座 CONVERSION TOOL HOLDER

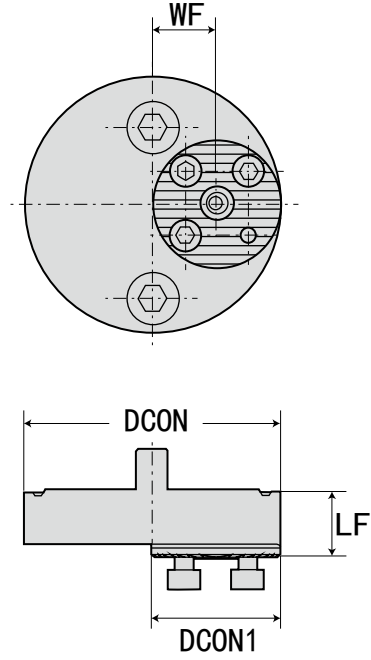

型号 Model	长度 LF	安装面直径 DCON	安装面直径 DCON1	H	中心距 WF	重量 KG
SD80-20-20-40R	20	80	40	37.5	20	0.8
SD80-20-30-40R	20	80	40	37.5	30	1.1

A

· 转换刀座 CONVERSION TOOL HOLDER

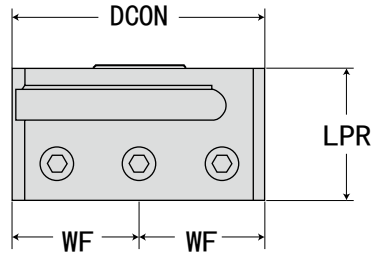
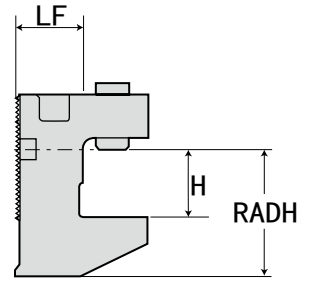
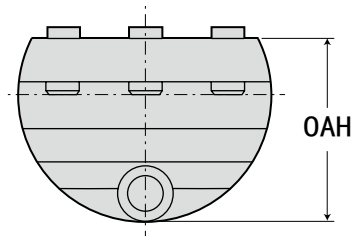

型号 Model	安装面直径 DCON	H	LPR	LF	WF	HF	OAW	OAH	重量 KG
SD80-20*20	80	37.5	40	20	38.5	20	77	56	0.7



· HSK63A - FMHC 阻尼减振铣刀杆 HSK63A - FMHC DAMPING MILLING TOOL HOLDER

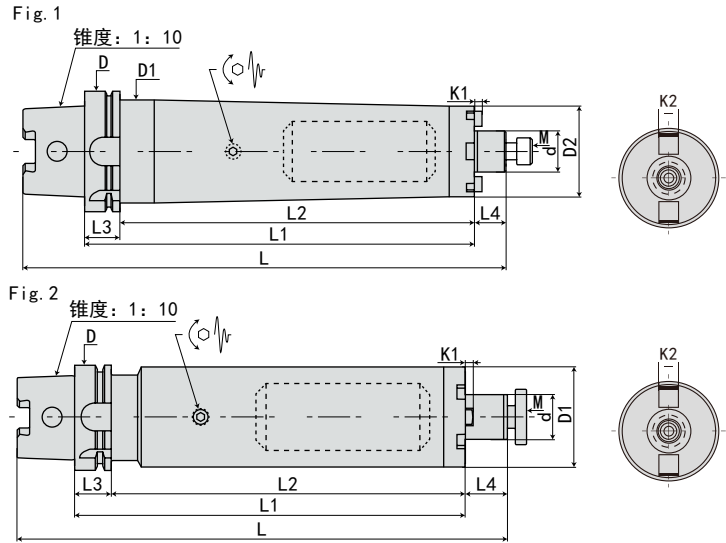

规格 Model	L	L1	L2	L3	L4	D	D1	D2	d	K1	K2	M	Fig	重量 KG
HSK63A - FMHC16 - 150 - D37	199	150	124	26	17	63	40	37	16	3.2	8	M8*1.25P	1	
-200 - D37	249	200	174	26	17	63	40	37	16	3.2	8	M8*1.25P	1	
-250 - D37	299	250	224	26	17	63	40	37	16	3.2	8	M8*1.25P	1	
-300 - D37	349	300	274	26	17	63	40	37	16	3.2	8	M8*1.25P	1	
-350 - D37	399	350	324	26	17	63	40	37	16	3.2	8	M8*1.25P	1	
-FMHC22 - 150 - D47	200	150	124	26	17	63	50	47	22	4.8	10	M10*1.25P	1	
-200 - D47	250	200	174	26	17	63	50	47	22	4.8	10	M10*1.25P	1	
-250 - D47	300	250	224	26	18	63	50	47	22	4.8	10	M10*1.25P	1	
-300 - D47	350	300	274	26	18	63	50	47	22	4.8	10	M10*1.25P	1	
-350 - D47	400	350	324	26	18	63	50	47	22	4.8	10	M10*1.25P	1	
-400 - D47	450	400	374	26	18	63	50	47	22	4.8	10	M10*1.25P	1	
-450 - D47	500	450	424	26	18	63	50	47	22	4.8	10	M10*1.25P	1	
-500 - D47	550	500	474	26	18	63	50	47	22	4.8	10	M10*1.25P	1	
-FMHC27 - 200 - D60	252	200	174	26	20	63	-	60	27	5.8	12	M12*1.75P	2	
-250 - D60	302	250	224	26	20	63	-	60	27	5.8	12	M12*1.75P	2	
-300 - D60	352	300	274	26	20	63	-	60	27	5.8	12	M12*1.75P	2	
-350 - D60	402	350	324	26	20	63	-	60	27	5.8	12	M12*1.75P	2	
-400 - D60	452	400	374	26	20	63	-	60	27	5.8	12	M12*1.75P	2	
-450 - D60	502	450	424	26	20	63	-	60	27	5.8	12	M12*1.75P	2	
-500 - D60	552	500	474	26	20	63	-	60	27	5.8	12	M12*1.75P	2	

规格说明:

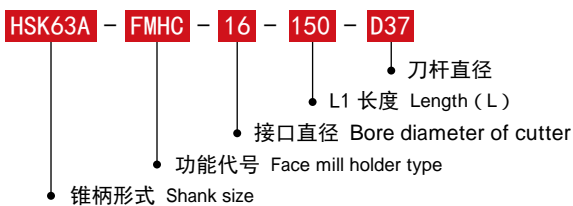

· HSK100A - FMHC 阻尼减振铣刀杆 HSK100A - FMHC DAMPING MILLING TOOL HOLDER

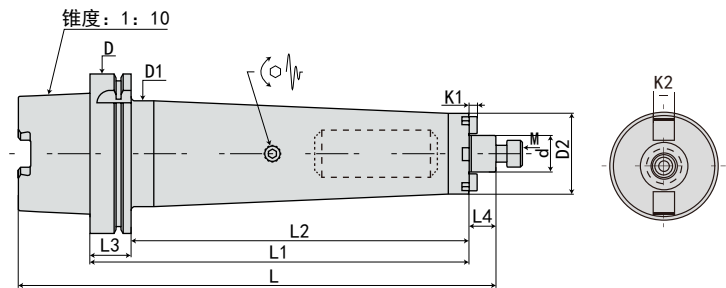

规格 Model	L	L1	L2	L3	L4	D	D1	D2	d	K1	K2	M	重量 KG
HSK100A - FMHC16 - 200 - D37	267	200	171	29	17	100	40	37	16	3.2	8	M8*1.25P	
-250 - D37	317	250	221	29	17	100	40	37	16	3.2	8	M8*1.25P	
-300 - D37	367	300	271	29	17	100	40	37	16	3.2	8	M8*1.25P	
-350 - D37	417	350	321	29	17	100	40	37	16	3.2	8	M8*1.25P	
-FMHC22 - 200 - D47	268	200	171	29	18	100	50	47	22	4.8	10	M10*1.25P	
-250 - D47	318	250	221	29	18	100	50	47	22	4.8	10	M10*1.25P	
-300 - D47	368	300	271	29	18	100	50	47	22	4.8	10	M10*1.25P	
-350 - D47	418	350	321	29	18	100	50	47	22	4.8	10	M10*1.25P	
-400 - D47	468	400	371	29	18	100	50	47	22	4.8	10	M10*1.25P	
-450 - D47	518	450	421	29	18	100	50	47	22	4.8	10	M10*1.25P	
-500 - D47	568	500	471	29	18	100	50	47	22	4.8	10	M10*1.25P	
-550 - D47	618	550	521	29	18	100	50	47	22	4.8	10	M10*1.25P	
-600 - D47	668	600	571	29	18	100	50	47	22	4.8	10	M10*1.25P	
-650 - D47	718	650	621	29	18	100	50	47	22	4.8	10	M10*1.25P	
-700 - D47	768	700	671	29	18	100	50	47	22	4.8	10	M10*1.25P	
-250 - D58	318	250	221	29	18	100	62	58	22	4.8	10	M10*1.25P	
-300 - D58	368	300	271	29	18	100	62	58	22	4.8	10	M10*1.25P	
-350 - D58	418	350	321	29	18	100	62	58	22	4.8	10	M10*1.25P	
-400 - D58	468	400	371	29	18	100	62	58	22	4.8	10	M10*1.25P	
-450 - D58	518	450	421	29	18	100	62	58	22	4.8	10	M10*1.25P	
-500 - D58	568	500	471	29	18	100	62	58	22	4.8	10	M10*1.25P	
-550 - D58	618	550	521	29	18	100	62	58	22	4.8	10	M10*1.25P	
-600 - D58	668	600	571	29	18	100	62	58	22	4.8	10	M10*1.25P	
-650 - D58	718	650	621	29	18	100	62	58	22	4.8	10	M10*1.25P	
-700 - D58	768	700	671	29	18	100	62	58	22	4.8	10	M10*1.25P	

规格说明:

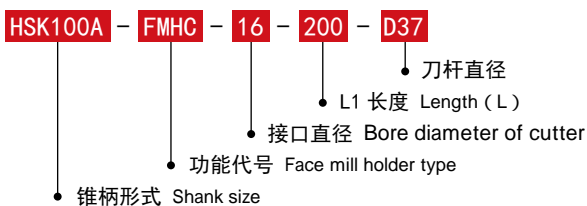

· HSK100A - FMHC 阻尼减振铣刀杆 HSK100A - FMHC DAMPING MILLING TOOL HOLDER

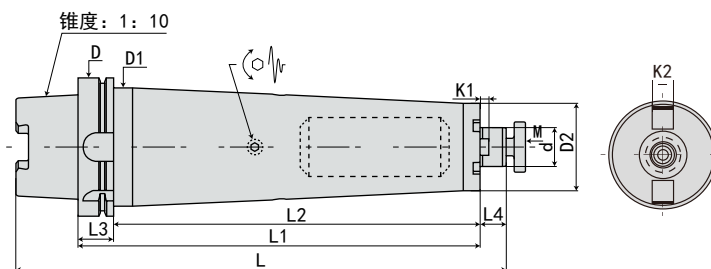

规格 Model	L	L1	L2	L3	L4	D	D1	D2	d	K1	K2	M	重量 KG
HSK100A - FMHC27 - 250 - D60	320	250	221	29	20	100	78	60	27	5.8	12	M12*1.75P	
- 300 - D60	370	300	271	29	20	100	78	60	27	5.8	12	M12*1.75P	
- 350 - D60	420	350	321	29	20	100	78	60	27	5.8	12	M12*1.75P	
- 400 - D60	470	400	371	29	20	100	78	60	27	5.8	12	M12*1.75P	
- 450 - D60	520	450	421	29	20	100	78	60	27	5.8	12	M12*1.75P	
- 500 - D60	570	500	471	29	20	100	78	60	27	5.8	12	M12*1.75P	
- 550 - D60	620	550	521	29	20	100	78	60	27	5.8	12	M12*1.75P	
- 600 - D60	670	600	571	29	20	100	78	60	27	5.8	12	M12*1.75P	
- 650 - D60	720	650	621	29	20	100	78	60	27	5.8	12	M12*1.75P	
- 700 - D60	770	700	671	29	20	100	78	60	27	5.8	12	M12*1.75P	
- 250 - D74	320	250	221	29	20	100	78	74	27	5.8	12	M12*1.75P	
- 300 - D74	370	300	271	29	20	100	78	74	27	5.8	12	M12*1.75P	
- 350 - D74	420	350	321	29	20	100	78	74	27	5.8	12	M12*1.75P	
- 400 - D74	470	400	371	29	20	100	78	74	27	5.8	12	M12*1.75P	
- 450 - D74	520	450	421	29	20	100	78	74	27	5.8	12	M12*1.75P	
- 500 - D74	570	500	471	29	20	100	78	74	27	5.8	12	M12*1.75P	
- 550 - D74	620	550	521	29	20	100	78	74	27	5.8	12	M12*1.75P	
- 600 - D74	670	600	571	29	20	100	78	74	27	5.8	12	M12*1.75P	
- 650 - D74	720	650	621	29	20	100	78	74	27	5.8	12	M12*1.75P	
- 700 - D74	770	700	671	29	20	100	78	74	27	5.8	12	M12*1.75P	
- FMHC32 - 250 - D80	322	250	221	29	22	100	95	80	32	6.8	14	M16*2.0P	
- 300 - D80	372	300	271	29	22	100	95	80	32	6.8	14	M16*2.0P	
- 350 - D80	422	350	321	29	22	100	95	80	32	6.8	14	M16*2.0P	
- 400 - D80	472	400	371	29	22	100	95	80	32	6.8	14	M16*2.0P	
- 450 - D80	522	450	421	29	22	100	95	80	32	6.8	14	M16*2.0P	
- 500 - D80	572	500	471	29	22	100	95	80	32	6.8	14	M16*2.0P	
- 550 - D80	622	550	521	29	22	100	95	80	32	6.8	14	M16*2.0P	
- 600 - D80	672	600	571	29	22	100	95	80	32	6.8	14	M16*2.0P	
- FMHC40 - 300 - D90	375	300	271	29	25	100	98	90	40	8.3	16	M16*2.0P	
- 350 - D90	425	350	321	29	25	100	98	90	40	8.3	16	M16*2.0P	
- 400 - D90	475	400	371	29	25	100	98	90	40	8.3	16	M16*2.0P	
- 450 - D90	525	450	421	29	25	100	98	90	40	8.3	16	M16*2.0P	
- 500 - D90	575	500	471	29	25	100	98	90	40	8.3	16	M16*2.0P	
- 550 - D90	625	550	521	29	25	100	98	90	40	8.3	16	M16*2.0P	
- 600 - D90	675	600	571	29	25	100	98	90	40	8.3	16	M16*2.0P	

规格说明:

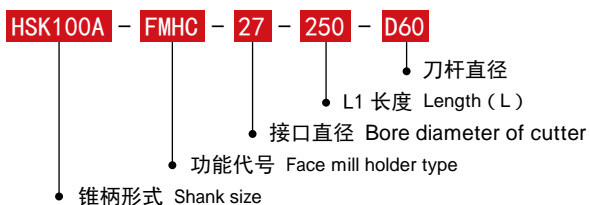

A

· HSK63A - CKC 阻尼减振镗刀

HSK63A - CKC DAMPING BORING TOOL



FIG. 1

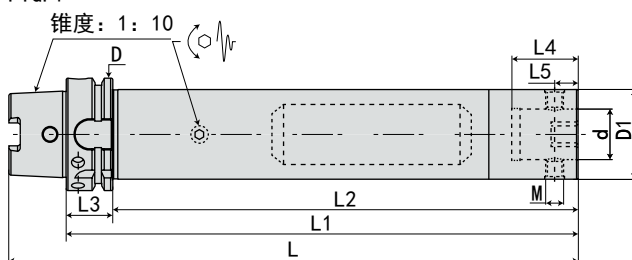
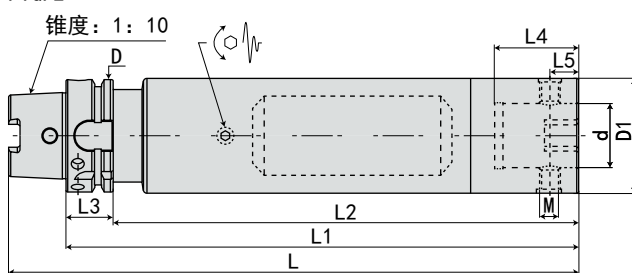
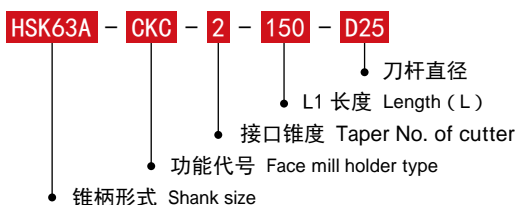

FIG. 2



规格 Model	L	L1	L2	L3	L4	L5	D	D1	d	M	FIG	重量 KG
HSK63A - CKC2 - 150 - D25	182	150	124	26	31	6.62	63	25	14	M5*0.5P		
- 175 - D25	207	175	149	26	31	6.62	63	25	14	M5*0.5P		
- 200 - D25	232	200	174	26	31	6.62	63	25	14	M5*0.5P		
- 200 - D32	232	200	174	26	35	8	63	32	18	M6*0.75P		
- 230 - D32	262	230	204	26	35	8	63	32	18	M6*0.75P		
- 260 - D32	292	260	234	26	35	8	63	32	18	M6*0.75P		
- 300 - D32	332	300	274	26	35	8	63	32	18	M6*0.75P		
- CKC4 - 235 - D40	267	235	209	26	39	10	63	40	22	M8*0.75P		
- 275 - D40	307	275	249	26	39	10	63	40	22	M8*0.75P		
- 315 - D40	347	315	289	26	39	10	63	40	22	M8*0.75P		
- 350 - D40	382	350	324	26	39	10	63	40	22	M8*0.75P		
- CKC5 - 315 - D50	347	315	289	26	45	13	63	50	28	M10*1.0P		
- 350 - D50	382	350	324	26	45	13	63	50	28	M10*1.0P		
- 400 - D50	432	400	374	26	45	13	63	50	28	M10*1.0P		
- 450 - D50	482	450	424	26	45	13	63	50	28	M10*1.0P		
- 500 - D50	532	500	474	26	45	13	63	50	28	M10*1.0P		
- CKC6 - 295 - D63	327	295	269	26	55	16	63	63	36	M12*1.0P		
- 350 - D63	382	350	324	26	55	16	63	63	36	M12*1.0P		
- 400 - D63	432	400	374	26	55	16	63	63	36	M12*1.0P		
- 450 - D63	482	450	424	26	55	16	63	63	36	M12*1.0P		
- 500 - D63	532	500	474	26	55	16	63	63	36	M12*1.0P		

规格说明:



· HSK100A - CKC 阻尼减振镗刀

HSK100A - CKC DAMPING BORING TOOL



FIG. 1

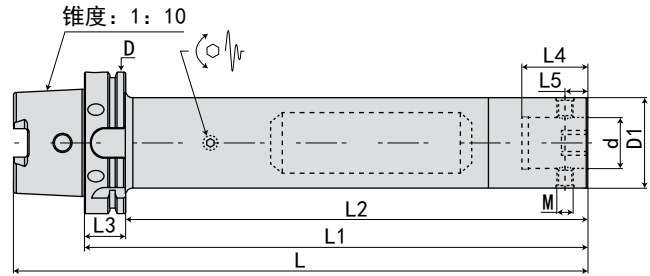
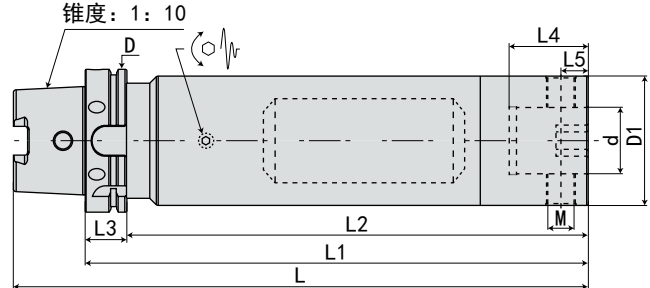

FIG. 2



规格 Model	L	L1	L2	L3	L4	L5	D	D1	d	M	FIG	重量 KG
HSK100A - CKC2 - 160 - D25	210	160	131	29	31	6.62	100	25	14	M5*0.5P		
- 185 - D25	235	185	156	29	31	6.62	100	25	14	M5*0.5P		
- 210 - D25	260	210	181	29	31	6.62	100	25	14	M5*0.5P		
- 250 - D25	300	250	221	29	31	6.62	100	25	14	M5*0.5P		
- 300 - D25	350	300	271	29	31	6.62	100	25	14	M5*0.5P		
- CKC3 - 220 - D32	270	220	191	29	35	8	100	32	18	M6*0.75P		
- 250 - D32	300	250	221	29	35	8	100	32	18	M6*0.75P		
- 280 - D32	330	280	251	29	35	8	100	32	18	M6*0.75P		
- 300 - D32	350	300	271	29	35	8	100	32	18	M6*0.75P		
- 350 - D32	400	350	321	29	35	8	100	32	18	M6*0.75P		
- CKC4 - 260 - D40	310	260	231	29	39	10	100	40	22	M8*0.75P		
- 300 - D40	350	300	271	29	39	10	100	40	22	M8*0.75P		
- 340 - D40	390	340	311	29	39	10	100	40	22	M8*0.75P		
- 400 - D40	450	400	371	29	39	10	100	40	22	M8*0.75P		
- CKC5 - 310 - D50	360	310	281	29	45	13	100	50	28	M10*1.0P		
- 355 - D50	405	355	326	29	45	13	100	50	28	M10*1.0P		
- 400 - D50	450	400	371	29	45	13	100	50	28	M10*1.0P		
- 450 - D50	500	450	421	29	45	13	100	50	28	M10*1.0P		
- 500 - D50	550	500	471	29	45	13	100	50	28	M10*1.0P		
- 600 - D50	650	600	571	29	45	13	100	50	28	M10*1.0P		
- 700 - D50	750	700	671	29	45	13	100	50	28	M10*1.0P		
- CKC6 - 375 - D63	425	375	346	29	55	16	100	63	36	M12*1.0P		
- 440 - D63	490	440	411	29	55	16	100	63	36	M12*1.0P		
- 500 - D63	550	500	471	29	55	16	100	63	36	M12*1.0P		
- 600 - D63	650	600	571	29	55	16	100	63	36	M12*1.0P		
- 700 - D63	750	700	671	29	55	16	100	63	36	M12*1.0P		
- CKC7 - 450 - D100	500	450	421	29	60	19.1	100	90	46	M20*1.5P		
- 500 - D100	550	500	471	29	60	19.1	100	90	46	M20*1.5P		
- 600 - D100	650	600	571	29	60	19.1	100	90	46	M20*1.5P		
- 700 - D100	750	700	671	29	60	19.1	100	90	46	M20*1.5P		

规格说明:



· HSK100A - BSTC 阻尼减振镗刀 HSK100A - BSTC DAMPING BORING TOOL

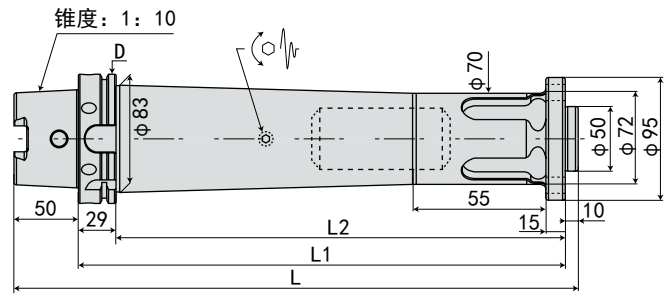

规格 Model	L	L1	L2	D	重量 KG
HSK100A - BSTC - 400	460	400	371	100	
- 450	510	450	421	100	
- 500	560	500	471	100	
- 600	660	600	571	100	
- 700	760	700	671	100	

规格说明:

HSK100A - BSTC - 400

- L1 长度 Length (L)
- 功能代号 Face mill holder type
- 锥柄形式 Shank size

· HSK63A - SNER 阻尼减振刀杆 HSK63A - SNER DAMPING BORING TOOL

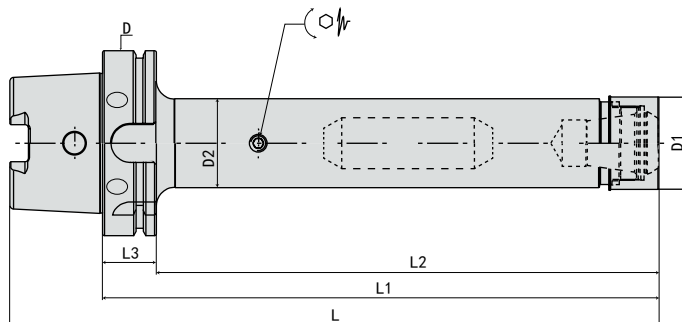

规格 Model	L	L1	L2	L3	D	D1	D2	夹持范围 Range	重量 KG
HSK63A - SNER25 - 180 - D38	202	180	154	26	63	38	40	1 - 16 mm	
- 230 - D38	252	230	204	26	63	38	40	1 - 16 mm	
- 280 - D38	302	280	254	26	63	38	40	1 - 16 mm	
- 330 - D38	352	330	304	26	63	38	40	1 - 16 mm	
- 380 - D38	402	380	354	26	63	38	40	1 - 16 mm	
- 430 - D38	452	430	404	26	63	38	40	1 - 16 mm	
- 500 - D38	522	500	474	26	63	38	40	1 - 16 mm	
- SNER32 - 180 - D48	202	180	154	26	63	48	50	2 - 20 mm	
- 230 - D48	252	230	204	26	63	48	50	2 - 20 mm	
- 280 - D48	302	280	254	26	63	48	50	2 - 20 mm	
- 330 - D48	352	330	304	26	63	48	50	2 - 20 mm	
- 380 - D48	402	380	354	26	63	48	50	2 - 20 mm	
- 430 - D48	452	430	404	26	63	48	50	2 - 20 mm	
- 500 - D48	522	500	474	26	63	48	50	2 - 20 mm	

规格说明:

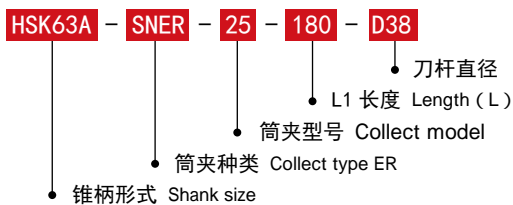

A

· HSK100A - SNER 阻尼减振刀杆 HSK100A - SNER DAMPING BORING TOOL

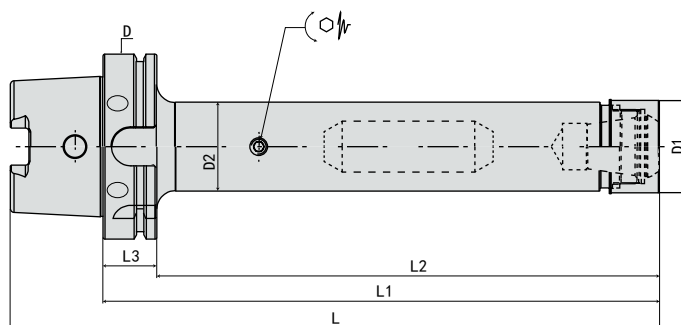

规格 Model	L	L1	L2	L3	D	D1	D2	夹持范围 Range	重量 KG
HSK100A - SNER25 - 230 - D38	270	230	201	29	100	38	40	1 - 16 mm	
- 280 - D38	320	280	251	29	100	38	40	1 - 16 mm	
- 330 - D38	370	330	301	29	100	38	40	1 - 16 mm	
- 380 - D38	420	380	351	29	100	38	40	1 - 16 mm	
- 430 - D38	470	430	401	29	100	38	40	1 - 16 mm	
- 480 - D38	520	480	451	29	100	38	40	1 - 16 mm	
- 530 - D38	570	530	501	29	100	38	40	1 - 16 mm	
- 600 - D38	640	600	571	29	100	38	40	1 - 16 mm	
- SNER32 - 230 - D48	270	230	201	29	100	48	50	2 - 20 mm	
- 280 - D48	320	280	251	29	100	48	50	2 - 20 mm	
- 330 - D48	370	330	301	29	100	48	50	2 - 20 mm	
- 380 - D48	420	380	351	29	100	48	50	2 - 20 mm	
- 430 - D48	470	430	401	29	100	48	50	2 - 20 mm	
- 480 - D48	520	480	451	29	100	48	50	2 - 20 mm	
- 530 - D48	570	530	501	29	100	48	50	2 - 20 mm	
- 580 - D48	620	580	551	29	100	48	50	2 - 20 mm	
- 630 - D48	670	630	601	29	100	48	50	2 - 20 mm	
- 700 - D48	740	700	671	29	100	48	50	2 - 20 mm	
- SNER40 - 230 - D58	270	230	201	29	100	58	63	2 - 26 mm	
- 280 - D58	320	280	251	29	100	58	63	2 - 26 mm	
- 330 - D58	370	330	301	29	100	58	63	2 - 26 mm	
- 380 - D58	420	380	351	29	100	58	63	2 - 26 mm	
- 430 - D58	470	430	401	29	100	58	63	2 - 26 mm	
- 480 - D58	520	480	451	29	100	58	63	2 - 26 mm	
- 530 - D58	570	530	501	29	100	58	63	2 - 26 mm	
- 580 - D58	620	580	551	29	100	58	63	2 - 26 mm	
- 630 - D58	670	630	601	29	100	58	63	2 - 26 mm	
- 700 - D58	740	700	671	29	100	58	63	2 - 26 mm	

规格说明:

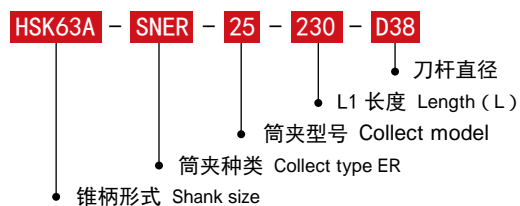

· SBT40-FMHC 阻尼减振铣刀杆 SBT40-FMHC DAMPING MILLING TOOL HOLDER

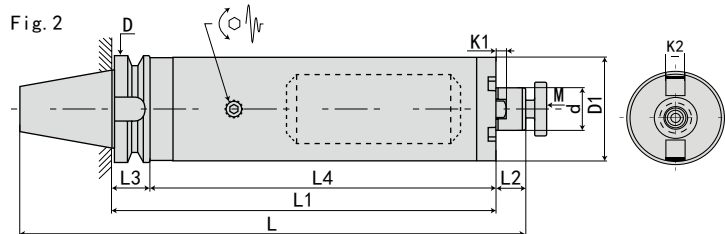
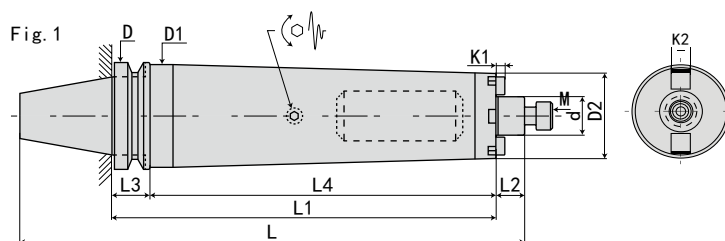

规格 Model	L	L1	L2	L3	L4	D	D1	D2	d	K1	K2	M	Fig	重量 KG
SBT40-FMHC16-150-D37	232.4	150	17	26	124	63	40	37	16	3.2	8	M8*1.25P	1	
-200-D37	282.4	200	17	26	174	63	40	37	16	3.2	8	M8*1.25P	1	
-250-D37	332.4	250	17	26	224	63	40	37	16	3.2	8	M8*1.25P	1	
-300-D37	382.4	300	17	26	274	63	40	37	16	3.2	8	M8*1.25P	1	
-350-D37	432.4	350	17	26	324	63	40	37	16	3.2	8	M8*1.25P	1	
-FMHC22-150-D47	233.4	150	18	26	124	63	50	47	22	4.8	10	M10*1.25P	1	
-200-D47	283.4	200	18	26	174	63	50	47	22	4.8	10	M10*1.25P	1	
-250-D47	333.4	250	18	26	224	63	50	47	22	4.8	10	M10*1.25P	1	
-300-D47	383.4	300	18	26	274	63	50	47	22	4.8	10	M10*1.25P	1	
-350-D47	433.4	350	18	26	324	63	50	47	22	4.8	10	M10*1.25P	1	
-400-D47	483.4	400	18	26	374	63	50	47	22	4.8	10	M10*1.25P	1	
-450-D47	533.4	450	18	26	424	63	50	47	22	4.8	10	M10*1.25P	1	
-500-D47	583.4	500	18	26	474	63	50	47	22	4.8	10	M10*1.25P	1	
-FMHC27-200-D60	283.4	200	20	26	174	63	-	60	27	5.8	12	M12*1.75P	2	
-250-D60	333.4	250	20	26	224	63	-	60	27	5.8	12	M12*1.75P	2	
-300-D60	383.4	300	20	26	274	63	-	60	27	5.8	12	M12*1.75P	2	
-350-D60	433.4	350	20	26	324	63	-	60	27	5.8	12	M12*1.75P	2	
-400-D60	483.4	400	20	26	374	63	-	60	27	5.8	12	M12*1.75P	2	
-450-D60	533.4	450	20	26	424	63	-	60	27	5.8	12	M12*1.75P	2	
-500-D60	583.4	500	20	26	474	63	-	60	27	5.8	12	M12*1.75P	2	

规格说明:

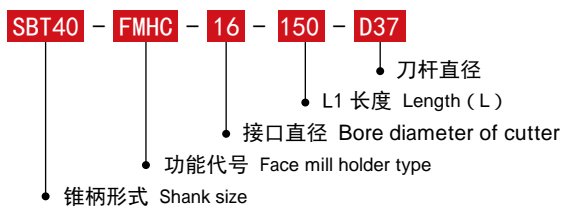

· SBT50-FMHC 阻尼减振铣刀杆 SBT50-FMHC DAMPING MILLING TOOL HOLDER

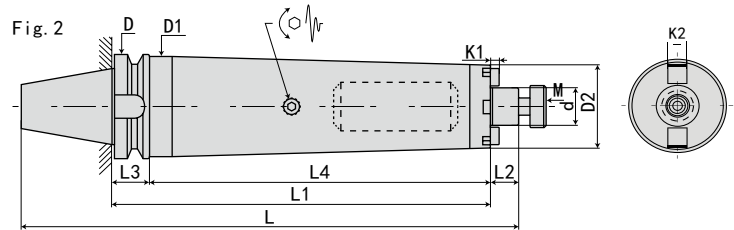
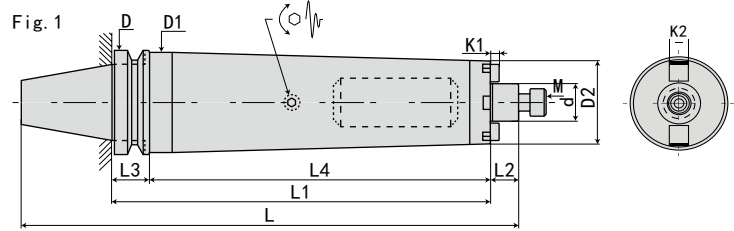

规格 Model	L	L1	L2	L3	L4	D	D1	D2	d	K1	K2	M	Fig	重量 KG
SBT50-FMHC22-600-D47	719.8	600	18	36.5	563.5	100	50	47	22	4.8	10	M10*1.25P	1	
-650-D47	769.8	650	18	36.5	613.5	100	50	47	22	4.8	10	M10*1.25P	1	
-700-D47	819.8	700	18	36.5	663.5	100	50	47	22	4.8	10	M10*1.25P	1	
-250-D58	369.8	250	18	36.5	213.5	100	62	58	22	4.8	10	M10*1.25P	1	
-300-D58	419.8	300	18	36.5	263.5	100	62	58	22	4.8	10	M10*1.25P	1	
-350-D58	469.8	350	18	36.5	313.5	100	62	58	22	4.8	10	M10*1.25P	1	
-400-D58	519.8	400	18	36.5	363.5	100	62	58	22	4.8	10	M10*1.25P	1	
-450-D58	569.8	450	18	36.5	413.5	100	62	58	22	4.8	10	M10*1.25P	1	
-500-D58	619.8	500	18	36.5	463.5	100	62	58	22	4.8	10	M10*1.25P	1	
-550-D58	669.8	550	18	36.5	513.5	100	62	58	22	4.8	10	M10*1.25P	1	
-600-D58	719.8	600	18	36.5	563.5	100	62	58	22	4.8	10	M10*1.25P	1	
-650-D58	769.8	650	18	36.5	613.5	100	62	58	22	4.8	10	M10*1.25P	1	
-700-D58	819.8	700	18	36.5	663.5	100	62	58	22	4.8	10	M10*1.25P	1	
-FMHC27-250-D58	371.8	250	20	36.5	213.5	100	62	58	27	5.8	12	M12*1.75P	2	
-300-D58	421.8	300	20	36.5	263.5	100	62	58	27	5.8	12	M12*1.75P	2	
-350-D58	471.8	350	20	36.5	313.5	100	62	58	27	5.8	12	M12*1.75P	2	
-400-D58	521.8	400	20	36.5	363.5	100	62	58	27	5.8	12	M12*1.75P	2	
-450-D58	571.8	450	20	36.5	413.5	100	62	58	27	5.8	12	M12*1.75P	2	
-500-D58	621.8	500	20	36.5	463.5	100	62	58	27	5.8	12	M12*1.75P	2	
-550-D58	671.8	550	20	36.5	513.5	100	62	58	27	5.8	12	M12*1.75P	2	
-600-D58	721.8	600	20	36.5	563.5	100	62	58	27	5.8	12	M12*1.75P	2	
-650-D58	771.8	650	20	36.5	613.5	100	62	58	27	5.8	12	M12*1.75P	2	
-700-D58	821.8	700	20	36.5	663.5	100	62	58	27	5.8	12	M12*1.75P	2	
-250-D74	371.8	250	20	36.5	213.5	100	78	74	27	5.8	12	M12*1.75P	2	
-300-D74	421.8	300	20	36.5	263.5	100	78	74	27	5.8	12	M12*1.75P	2	
-350-D74	471.8	350	20	36.5	313.5	100	78	74	27	5.8	12	M12*1.75P	2	
-400-D74	521.8	400	20	36.5	363.5	100	78	74	27	5.8	12	M12*1.75P	2	
-450-D74	571.8	450	20	36.5	413.5	100	78	74	27	5.8	12	M12*1.75P	2	
-500-D74	621.8	500	20	36.5	463.5	100	78	74	27	5.8	12	M12*1.75P	2	
-550-D74	671.8	550	20	36.5	513.5	100	78	74	27	5.8	12	M12*1.75P	2	
-600-D74	721.8	600	20	36.5	563.5	100	78	74	27	5.8	12	M12*1.75P	2	
-650-D74	771.8	650	20	36.5	613.5	100	78	74	27	5.8	12	M12*1.75P	2	
-700-D74	821.8	700	20	36.5	663.5	100	78	74	27	5.8	12	M12*1.75P	2	

规格说明:

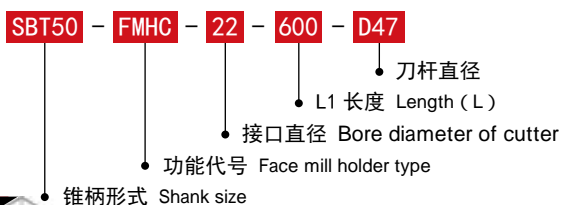

· SBT50-FMHC 阻尼减振铣刀杆 SBT50-FMHC DAMPING MILLING TOOL HOLDER

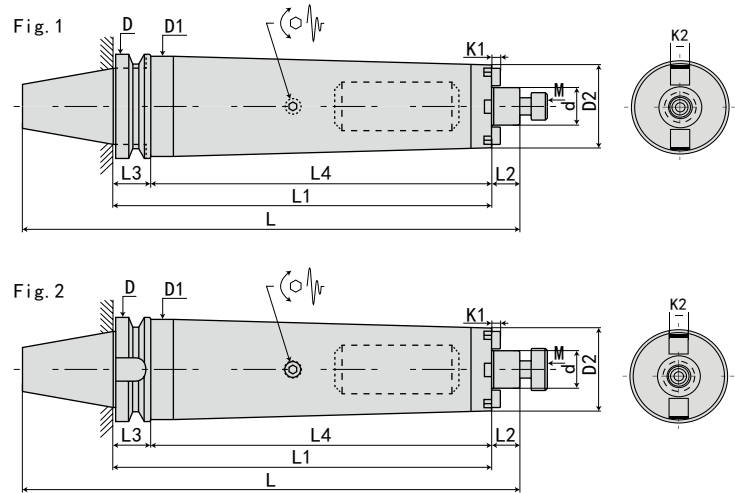

规格 Model	L	L1	L2	L3	L4	D	D1	D2	d	K1	K2	M	Fig	重量 KG
SBT50-FMHC32-250-D80	373.8	250	22	36.5	213.5	100	95	80	32	6.8	14	M16*2.0P	2	
-300-D80	423.8	300	22	36.5	263.5	100	95	80	32	6.8	14	M16*2.0P	2	
-350-D80	473.8	350	22	36.5	313.5	100	95	80	32	6.8	14	M16*2.0P	2	
-400-D80	523.8	400	22	36.5	363.5	100	95	80	32	6.8	14	M16*2.0P	2	
-450-D80	573.8	450	22	36.5	413.5	100	95	80	32	6.8	14	M16*2.0P	2	
-500-D80	623.8	500	22	36.5	463.5	100	95	80	32	6.8	14	M16*2.0P	2	
-550-D80	673.8	550	22	36.5	513.5	100	95	80	32	6.8	14	M16*2.0P	2	
-600-D80	723.8	600	22	36.5	563.5	100	95	80	32	6.8	14	M16*2.0P	2	
-FMHC40-300-D90	426.8	300	25	36.5	263.5	100	98	90	40	8.3	16	M16*2.0P	2	
-350-D90	476.8	350	25	36.5	313.5	100	98	90	40	8.3	16	M16*2.0P	2	
-400-D90	526.8	400	25	36.5	363.5	100	98	90	40	8.3	16	M16*2.0P	2	
-450-D90	576.8	450	25	36.5	413.5	100	98	90	40	8.3	16	M16*2.0P	2	
-500-D90	626.8	500	25	36.5	463.5	100	98	90	40	8.3	16	M16*2.0P	2	
-550-D90	676.8	550	25	36.5	513.5	100	98	90	40	8.3	16	M16*2.0P	2	
-600-D90	726.8	600	25	36.5	563.5	100	98	90	40	8.3	16	M16*2.0P	2	

规格说明:

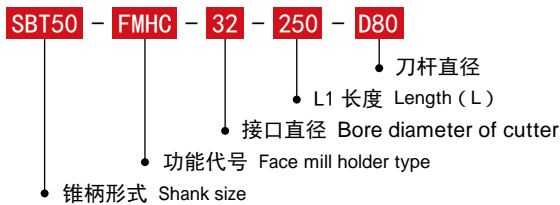

· SBT40-CKC 阻尼减振镗刀

SBT40-CKC DAMPING BORING TOOL

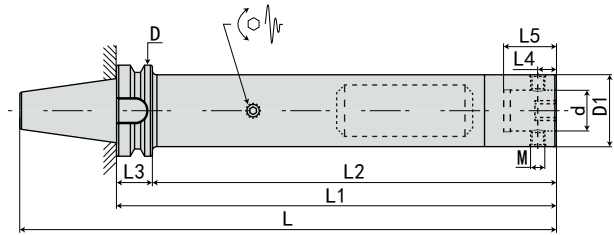

规格 Model	L	L1	L2	L3	L4	L5	D	D1	d	M	重量 KG
SBT40-CKC2-150-D25	215.4	150	124	26	6.62	31	63	25	14	M5*0.5P	
-175-D25	240.4	175	149	26	6.62	31	63	25	14	M5*0.5P	
-200-D25	265.4	200	174	26	6.62	31	63	25	14	M5*0.5P	
-CKC3-200-D32	265.4	200	174	26	8	35	63	32	18	M6*0.75P	
-230-D32	295.4	230	204	26	8	35	63	32	18	M6*0.75P	
-260-D32	325.4	260	234	26	8	35	63	32	18	M6*0.75P	
-300-D32	365.4	300	274	26	8	35	63	32	18	M6*0.75P	
-CKC4-235-D40	300.4	235	209	26	10	39	63	40	22	M8*0.75P	
-275-D40	340.4	275	249	26	10	39	63	40	22	M8*0.75P	
-315-D40	380.4	315	289	26	10	39	63	40	22	M8*0.75P	
-350-D40	415.4	350	324	26	10	39	63	40	22	M8*0.75P	
-CKC5-310-D50	375.4	310	284	26	13	45	63	50	28	M10*1.0P	
-350-D50	415.4	350	324	26	13	45	63	50	28	M10*1.0P	
-400-D50	465.4	400	374	26	13	45	63	50	28	M10*1.0P	
-450-D50	515.4	450	424	26	13	45	63	50	28	M10*1.0P	
-500-D50	565.4	500	474	26	13	45	63	50	28	M10*1.0P	
-CKC6-295-D63	360.4	295	269	26	16	55	63	63	36	M12*1.0P	
-350-D63	415.4	350	324	26	16	55	63	63	36	M12*1.0P	
-400-D63	465.4	400	374	26	16	55	63	63	36	M12*1.0P	
-450-D63	515.4	450	424	26	16	55	63	63	36	M12*1.0P	
-500-D63	565.4	500	474	26	16	55	63	63	36	M12*1.0P	

规格说明:

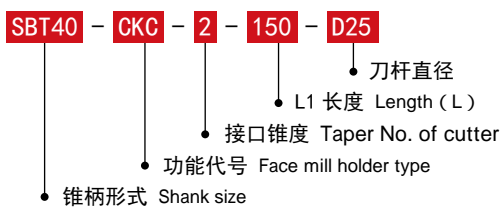

· SBT50-CKC 阻尼减振镗刀

SBT50-CKC DAMPING BORING TOOL

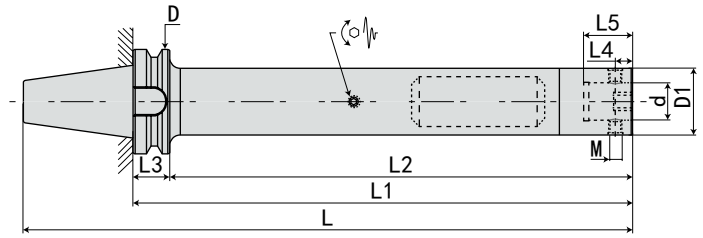

规格 Model	L	L1	L2	L3	L4	L5	D	D1	d	M	重量 KG
SBT50-CKC2-160-D25	261.8	160	123.5	36.5	6.62	31	100	25	14	M5*0.5P	
-185-D25	286.8	185	148.5	36.5	6.62	31	100	25	14	M5*0.5P	
-210-D25	311.8	210	173.5	36.5	6.62	31	100	25	14	M5*0.5P	
-250-D25	351.8	250	213.5	36.5	6.62	31	100	25	14	M5*0.5P	
-300-D25	401.8	300	263.5	36.5	6.62	31	100	25	14	M5*0.5P	
-CKC3-220-D32	321.8	220	183.5	36.5	8	35	100	32	18	M6*0.75P	
-250-D32	351.8	250	213.5	36.5	8	35	100	32	18	M6*0.75P	
-280-D32	381.8	280	243.5	36.5	8	35	100	32	18	M6*0.75P	
-300-D32	401.8	300	263.5	36.5	8	35	100	32	18	M6*0.75P	
-350-D32	451.8	350	313.5	36.5	8	35	100	32	18	M6*0.75P	
-CKC4-260-D40	361.8	260	223.5	36.5	10	39	100	40	22	M8*0.75P	
-300-D40	401.8	300	263.5	36.5	10	39	100	40	22	M8*0.75P	
-340-D40	441.8	340	303.5	36.5	10	39	100	40	22	M8*0.75P	
-400-D40	501.8	400	363.5	36.5	10	39	100	40	22	M8*0.75P	
-CKC5-310-D50	411.8	310	273.5	36.5	13	45	100	50	28	M10*1.0P	
-355-D50	456.8	355	318.5	36.5	13	45	100	50	28	M10*1.0P	
-400-D50	501.8	400	363.5	36.5	13	45	100	50	28	M10*1.0P	
-450-D50	551.8	450	413.5	36.5	13	45	100	50	28	M10*1.0P	
-500-D50	601.8	500	463.5	36.5	13	45	100	50	28	M10*1.0P	
-600-D50	701.8	600	563.5	36.5	13	45	100	50	28	M10*1.0P	
-700-D50	801.8	700	663.5	36.5	13	45	100	50	28	M10*1.0P	
-CKC6-375-D63	476.8	375	338.5	36.5	16	55	100	63	36	M12*1.0P	
-440-D63	541.8	440	403.5	36.5	16	55	100	63	36	M12*1.0P	
-500-D63	601.8	500	463.5	36.5	16	55	100	63	36	M12*1.0P	
-600-D63	701.8	600	563.5	36.5	16	55	100	63	36	M12*1.0P	
-700-D63	801.8	700	663.5	36.5	16	55	100	63	36	M12*1.0P	
-CKC7-450-D100	551.8	450	413.5	36.5	19.1	60	100	90	46	M20*1.50P	
-500-D100	601.8	500	463.5	36.5	19.1	60	100	90	46	M20*1.50P	
-600-D100	701.8	600	563.5	36.5	19.1	60	100	90	46	M20*1.50P	
-700-D100	801.8	700	663.5	36.5	19.1	60	100	90	46	M20*1.50P	

规格说明:

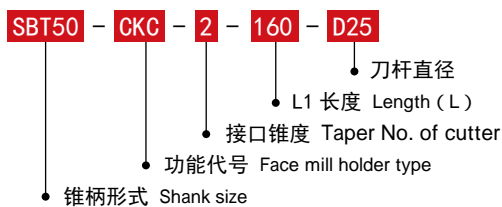

· SBT50-BSTC 阻尼减振镗刀 SBT50-BSTC DAMPING BORING TOOL

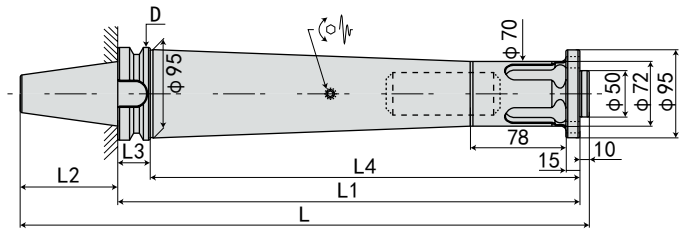

规格 Model	L	L1	L2	L3	L4	D	重量 KG
SBT50-BSTC-400	501.8	400	101.8	36.5	363.5	100	
-450	551.8	450	101.8	36.5	413.5	100	
-500	601.8	500	101.8	36.5	463.5	100	
-600	701.8	600	101.8	36.5	563.5	100	
-700	801.8	700	101.8	36.5	663.5	100	

规格说明:

- SBT50 - BSTC - 400
- L1 长度 Length (L)
 - 功能代号 Face mill holder type
 - 锥柄形式 Shank size

· SBT40-SNER 阻尼减振刀柄 SBT40-SNER DAMPING ANTI-VIBRATION TOOL HOLDER

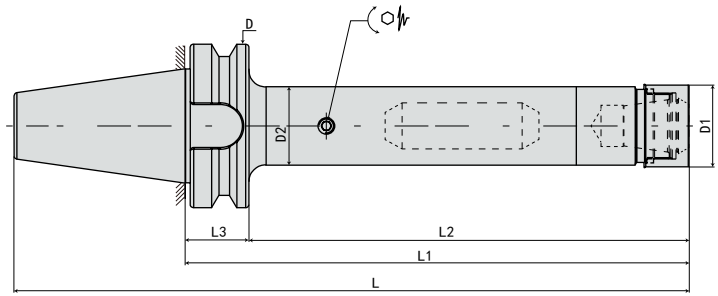

规格 Model	L	L1	L2	L3	D	D1	D2	夹持范围 Range	重量 KG
SBT40-SNER25-180-D38	235.4	180	154	26	63	38	40	1-16 mm	
-230-D38	285.4	230	204	26	63	38	40	1-16 mm	
-280-D38	335.4	280	254	26	63	38	40	1-16 mm	
-330-D38	385.4	330	304	26	63	38	40	1-16 mm	
-380-D38	435.4	380	354	26	63	38	40	1-16 mm	
-430-D38	485.4	430	404	26	63	38	40	1-16 mm	
-500-D38	555.4	500	474	26	63	38	40	1-16 mm	
-SNER32-180-D48	235.4	180	154	26	63	48	50	2-20 mm	
-230-D48	285.4	230	204	26	63	48	50	2-20 mm	
-280-D48	335.4	280	254	26	63	48	50	2-20 mm	
-330-D48	385.4	330	304	26	63	48	50	2-20 mm	
-380-D48	435.4	380	354	26	63	48	50	2-20 mm	
-430-D48	485.4	430	404	26	63	48	50	2-20 mm	
-500-D48	555.4	500	474	26	63	48	50	2-20 mm	

规格说明:

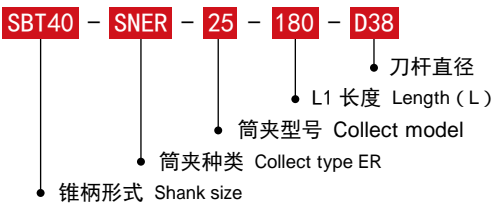

A
阻尼减振刀具
DAMPING TOOLS

· SBT50-SNER 阻尼减振刀柄

SBT50-SNER DAMPING ANTI-VIBRATION TOOL HOLDER

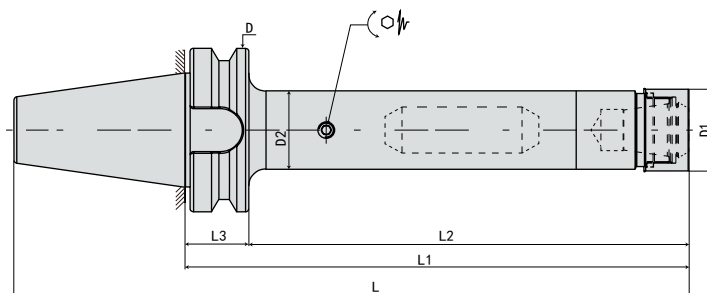

规格 Model	L	L1	L2	L3	D	D1	D2	夹持范围 Range	重量 KG
SBT50-SNER25-230-D38	321.8	230	193.5	36.5	100	38	40	1-16 mm	
-280-D38	371.8	280	243.5	36.5	100	38	40	1-16 mm	
-330-D38	421.8	330	293.5	36.5	100	38	40	1-16 mm	
-380-D38	471.8	380	343.5	36.5	100	38	40	1-16 mm	
-430-D38	521.8	430	393.5	36.5	100	38	40	1-16 mm	
-480-D38	571.8	480	443.5	36.5	100	38	40	1-16 mm	
-530-D38	621.8	530	493.5	36.5	100	38	40	1-16 mm	
-600-D38	691.8	600	563.5	36.5	100	38	40	1-16 mm	
-SNER32-230-D48	321.8	230	193.5	36.5	100	48	50	2-20 mm	
-280-D48	371.8	280	243.5	36.5	100	48	50	2-20 mm	
-330-D48	421.8	330	293.5	36.5	100	48	50	2-20 mm	
-380-D48	471.8	380	343.5	36.5	100	48	50	2-20 mm	
-430-D48	521.8	430	393.5	36.5	100	48	50	2-20 mm	
-480-D48	571.8	480	443.5	36.5	100	48	50	2-20 mm	
-530-D48	621.8	530	493.5	36.5	100	48	50	2-20 mm	
-580-D48	671.8	580	543.5	36.5	100	48	50	2-20 mm	
-630-D48	721.8	630	593.5	36.5	100	48	50	2-20 mm	
-700-D48	791.8	700	663.5	36.5	100	48	50	2-20 mm	
-SNER40-230-D58	321.8	230	193.5	36.5	100	58	63	2-26 mm	
-280-D58	371.8	280	243.5	36.5	100	58	63	2-26 mm	
-330-D58	421.8	330	293.5	36.5	100	58	63	2-26 mm	
-380-D58	471.8	380	343.5	36.5	100	58	63	2-26 mm	
-430-D58	521.8	430	393.5	36.5	100	58	63	2-26 mm	
-480-D58	571.8	480	443.5	36.5	100	58	63	2-26 mm	
-530-D58	621.8	530	493.5	36.5	100	58	63	2-26 mm	
-580-D58	671.8	580	543.5	36.5	100	58	63	2-26 mm	
-630-D58	721.8	630	593.5	36.5	100	58	63	2-26 mm	
-700-D58	791.8	700	663.5	36.5	100	58	63	2-26 mm	

规格说明:

